

# eDrum*in*

# USER MANUAL

# eDRUM*in*



Version 2.0.1

# Table of Contents

<b>Introduction.....</b>	<b>4</b>
Features at a Glance.....	4
The Hardware and Connections.....	5
Supported Pads.....	6
Supported Hihat Controllers.....	6
<b>Getting Started.....</b>	<b>7</b>
Attaching the Drum Stand Clip.....	7
Installing the Control Application.....	8
Enabling eDRUMin in your MIDI Applications.....	8
Connecting Drum Pads.....	9
Loading a Pad Preset.....	9
Drum Maps and Kit Pieces.....	10
Changing Drums Maps.....	10
Setting up a Hihat Controller.....	11
<b>The Control Application.....</b>	<b>12</b>
The Input Selector.....	12
Sidebar.....	13
Trigger Editor.....	13
Pad / Input Type Settings.....	14
Calibrate Mode.....	15
Transient Scanning Controls.....	16
Crosstalk Cancellation.....	17
Articulation Scalers.....	17
Sense Controls.....	18
Rimshot Range.....	18
Hotspot Suppression.....	18
Edge Sense.....	19
Bell Sense.....	19
Positional Sensing.....	20
Note Panel.....	21
Assigning MIDI Note Values to Articulations.....	21
Load Notes from a Drum Map.....	22
Velocity Curves.....	22
Advanced Mode.....	23
Working With Note Banks.....	23
Working with Independent Curves.....	23
Using a Roland BT-1.....	24

Preset Manager.....	25
Creating User Presets.....	26
Working with User Presets.....	26
Importing Presets.....	26
Drum Map Editor.....	27
Pedal Editor.....	29
Pedal Type and Pedal Sensing.....	29
Hihat Controllers and Expression Pedals.....	30
Calibrating Your Pedal.....	30
Modes for Expression Pedals and Hihat Controllers.....	30
CC Mode vs. Levels Mode.....	31
Adjusting the Responsiveness Closed Hihat Notes and Splashes.....	32
Velocity Curve.....	32
Advanced Hihat Options.....	33
Setting up VH-12 and Hall Effect Sensors.....	34
Sustain Pedals and Footswitches.....	35
Using a Latching Type Footswitch.....	35
Modes for Sustain Pedals and Footswiches.....	35
Using a Pedal for Bank Changes.....	36
MIDI Monitor.....	37
<b>eDRUMin 10 USB Host Port and MIDI Ports.....</b>	<b>38</b>
The Flow of MIDI Messages.....	38
Processing External MIDI.....	39
<b>Updating Firmware.....</b>	<b>40</b>
<b>iOS Control Application.....</b>	<b>41</b>
Getting Connected.....	41
Camera Connection Kit.....	41
Network MIDI.....	41
About Power in iOS.....	42
<b>Appendix.....</b>	<b>43</b>
Working With Multiple Devices on Separate USB Ports.....	43
Controlling Banks with MIDI Program Change Messages.....	44
Setting up your Hihat on its Stand.....	45
Tips For Working with Audiofront Controls.....	46
Drum Pad Wiring Diagrams.....	47
Pedal Input Wiring Diagrams.....	48
MIDI Implementation.....	49

# Introduction

## Features at a Glance

eDRUMin devices are e-drum to MIDI interfaces with universal trigger inputs supporting pad, cymbals, and acoustic triggers. Flexible trigger circuitry that allows them to support both piezo / piezo pads and piezo / switch pads. 10 bit sampling at up to 10K samples / per second / input ensures high resolution triggering with extremely low internal latency and jitter.



Supports Roland and Yamaha 3-way triggering



Roland Bell Sense for 3-Way triggering using a single input



Hotspot suppression for mesh pads.



Full Size MIDI ports for interfacing 3<sup>rd</sup> party gear \*



Positional Sensing for cymbals and mesh pads with center mounted piezo.



Hihat input supporting Yamaha and Roland style controllers



Bezier Velocity Curves



USB Host port for expansion \*\*



Ultra compact and portable design



Powerful and intelligent UI for easy setup

\* eDRUMin 4 only has a MIDI Out port while the eDRUMin 10 has both MIDI In and Out.

\*\* USB Host port is only available on the eDRUMin 10.

## The Hardware and Connections

# eDRUMin 4

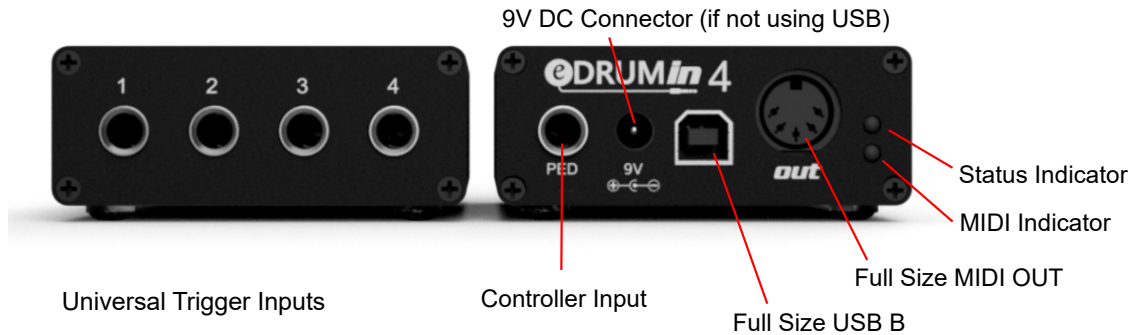

# eDRUMin 10

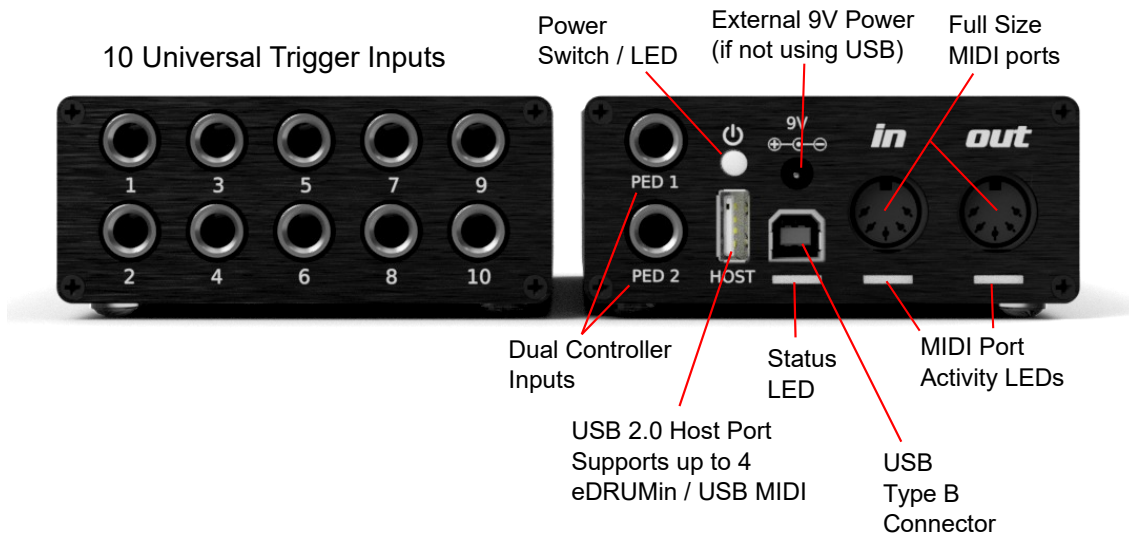

### Pedal Input



The pedal input on the back of the eDRUMin does not support drum pads. The Jack uses DC current which can damage the drum pads. Look on the next page for more information about the type of pedals you can connect.

### DC Power Connector

eDRUMin typically gets its power from the USB cable. If you want to use your eDRUMin without a USB connection, you can power it using a USB charger or the DC Power Jack.

eDRUMin devices use a BOSS style jack, where the center pin is negative. The eDRUMin 4 needs at least 100mA, and the eDRUMin 10 needs at least 200mA, or 600mA if also using the USB host port. The BOSS PSA-120S is great choice for either device.

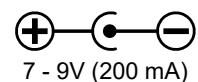

## Supported Pads

eDRUMin supports all kinds of e-drum pads and triggers. It doesn't matter if your pads are made by Roland, Yamaha, Alesis or anyone else; they are well supported. Here's a list of the gear used during development.

### Electric Drum Pads

Roland PDX-125k  
Roland PD-8  
Roland KD-8  
Roland KT-10  
Roland HD-1 Toms  
Roland BT-1  
Yamaha TP-65s  
Yamaha TP-120SD  
DDT MS-140C

### Electric Cymbals

Roland CY-13R  
Roland CY-15R  
Roland CY-8  
Roland VH-10 Hihat  
Roland VH-13 Hihat  
Yamaha PCY155  
Lemon 18" Ride

### Acoustic Triggers

Roland RT-30HR

**Note:** Center mounted mesh trigger systems that use cylinders instead of cones (Jobeky for example) tend to produce signals that are too hot for the eDRUMin inputs. Visit the eDRUMin forums for [more information](#).

## Supported Hihat Controllers

The hihat controller input on the back of the device supports both Roland and Yamaha style hihat controllers, expression pedals, sustain pedals, and footswitches. Look in the [Appendix](#) for wiring diagrams for supported pedal types.

**Note:** When setup as an expression pedal, the pedal input can supply 3.3V to power most 3.3V compatible Hall effect sensors.

Typically this input is used for a hihat controller, but it can also be used to Change Banks of notes, send Control Change messages and more.

Pedal Sensing automatically sets up your pedal. Always connect the cable to your pedal before connecting to the eDRUMin. Look [here](#) to see what the various types of pedals can do. Here's a list of the pedals I used during development.

### Hihat Controllers

Yamaha HH65  
Roland FD-8  
Roland VH-11  
Roland VH-13

### Expression Pedals

Moog EP-3  
Roland EV-5  
Yamaha FC7  
M-Audio EX-P  
Behringer FCV100  
Line6 EX 1

### Sustain Pedals

Yamaha FC3A  
Yamaha FC4  
Yamaha FC5A  
Roland DP-10

### Footswitches

Yamaha FC5  
Boss FS-7  
Marshall 90010

# Getting Started

## Attaching the Drum Stand Clip

You can use the optional drum stand clip to attach your eDRUMin to the frame of a drum stand or a hihat stand.

Below are instructions for attaching the clip of the eDRUMin 4, but the process is the same for the eDRUMin 10. Make sure your clip is very tight to ensure there's enough friction to prevent slipping.

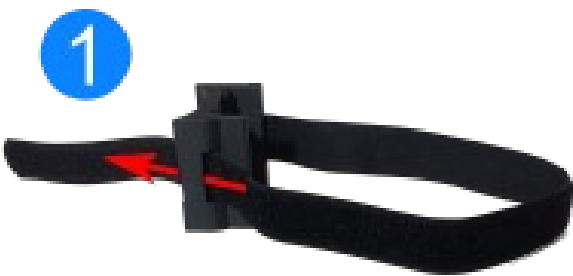

Insert the strap through the slot to make a loop.



Place the eDRUMin inside the loop. With the device centered on the clip, pull the strap tight.



Place the device and the clip against the frame of your drum stand. Wrap the strap around the frame and insert it through the slot.



Pull the strap very tight and wrap back around the device. Stick the Velcro to secure it in place.

Because eDRUMin devices are class compliant, there's no need to install drivers. You will however want to install the Control Application to edit the device settings.

## Installing the Control Application

The Control application is available for Windows, macOS, Linux, and iOS and can be downloaded from the Audiofront [downloads](#).

The [Control Application](#) is discussed in detail in the next section of the manual.

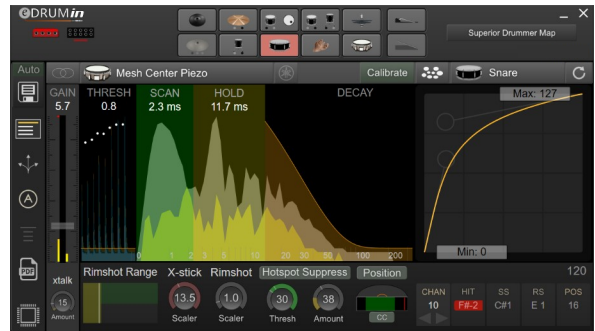

## Enabling eDRUMin in your MIDI Applications

When you use your eDRUMin for the first time with a new application, you might need to enable it for input in the application's audio / MIDI setup. Here are some screenshots showing how to enable eDRUMin in various applications.

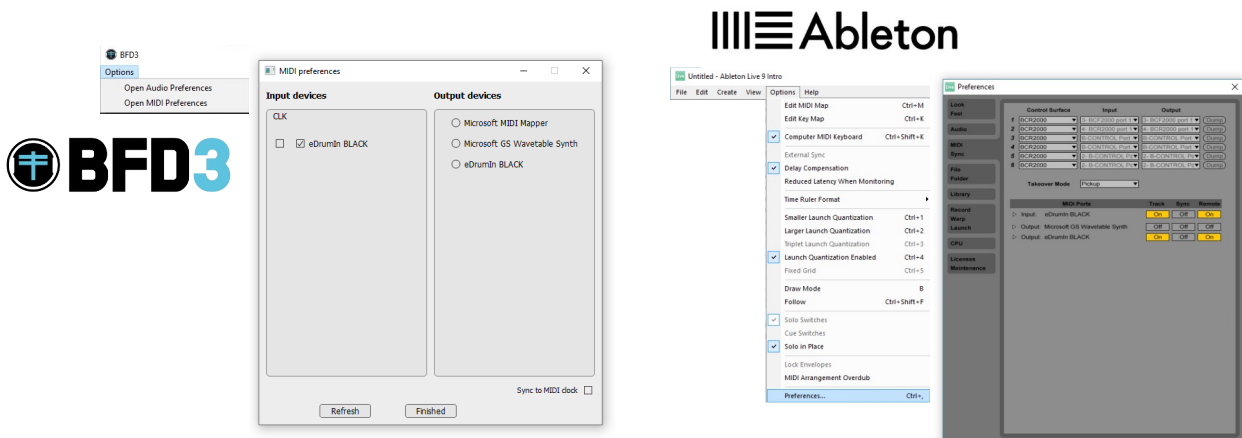
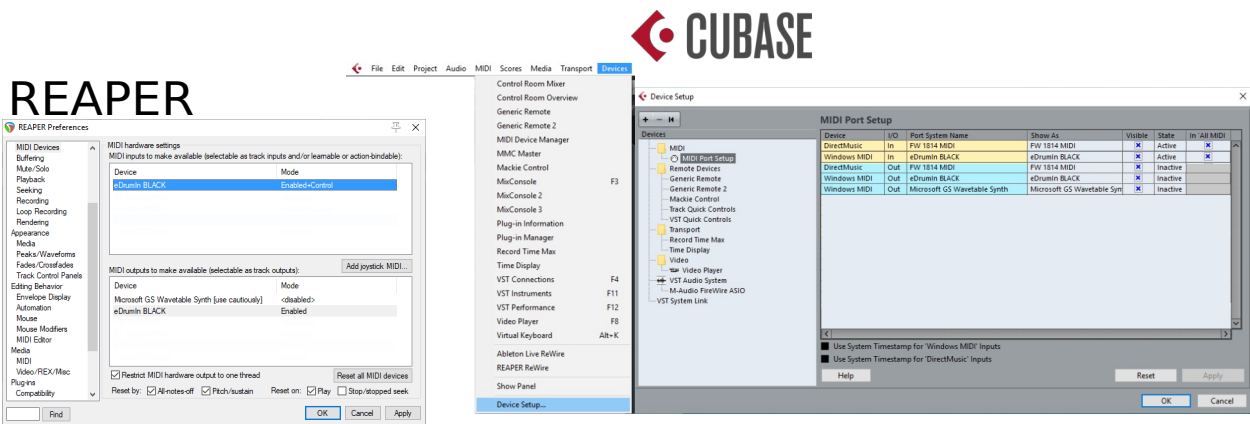



## Connecting Drum Pads

The 1/4" inputs on the front of the device are for connecting drum pads. Make sure you connect your pads with TRS connectors. The device is not designed to work with TS connectors. Even if you are using a single zone pad, you should still connect it with a TRS cable.



Some ride cymbals have two TRS connectors. If you plan to use both connections for 3-way triggering, connect them to two adjacent inputs as shown in the image below. Next, set the pad type of the BOW / EGDE input to 'Roland 3-Zone Ride' and the second input will automatically be marked as 'Bell'



For **ED10**, the BOW / EDGE connector should be plugged into the top input, and the BOW / BELL on the bottom.



For **ED4**, the BOW / EDGE connector should be on left, and the BOW / BELL should be on the right.

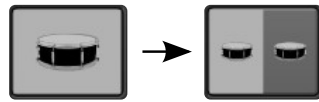

Inputs can be split to allow connecting two pads to a single input using a splitter cable. Once split, each half of the input will have its own set of trigger settings.

Change to Input to Dual Mono to split the input

## Loading a Pad Preset

You can load presets for your pads by clicking on the Preset Manager Icon.



- 1 Open the Preset Manager
- 2 Select an input
- 3 Double-click a preset to load it

Filter presets by brand

Filter presets by type

Factory	User	Title	Description
23	3	Roland PD-125	Roland PD-125
		Roland HD-1 Tom Pad	
		Roland CY-8	
		Roland VH-10	12" dual zone mesh pad with positional sensing
		Roland CY-15R	
		Roland CY-13R	
		Yamaha PCY-150s	Author
		Yamaha TP65S	Robert Jonkman
		DDT-MS140C	Brand
		Roland KD-8	Roland
		Roland KT-10	Drum
		Yamaha TP-120SD	Date
		Roland VH-13	May 16 2020
			ED10R2

If a preset for your pad is not available, you'll need to set it up manually by [setting the pad type](#) and [adjusting its trigger settings](#).

Look [here](#) for more information about use the Preset Manager.

## Drum Maps and Kit Pieces

eDRUMin uses the idea of drum maps and kit pieces. The device contains a drum map and inputs are assigned to kit pieces. The device determines which notes a particular input should trigger by looking them up from the drum map.

This system allows the user to trigger different hardware / software by simply changing drum maps.

Click on Kit Piece selector, shown right, to reveal and select a kit piece.

Click to select Kit Piece



## Changing Drums Maps

eDRUMin comes with several factory drum maps. You can access them by clicking on the drum map indicator.

Double click on a factory drum map to send it to your device.

Click to change drum maps.

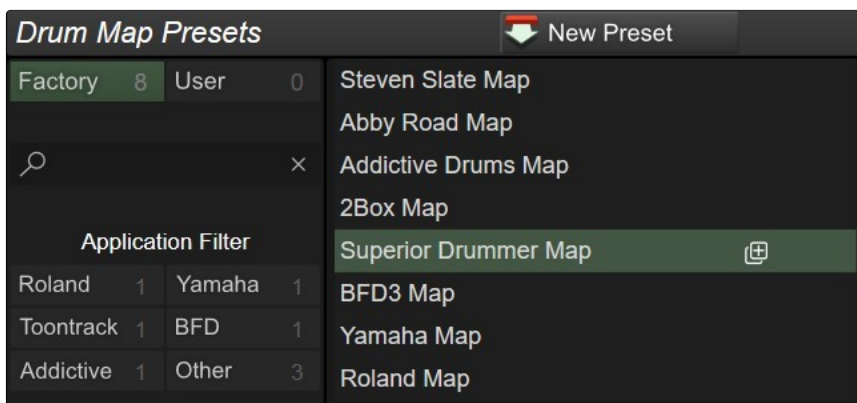

Users can create their own drum maps and edit them for their own needs.

Look [here](#) for more information about the Drum Map Editor.

## Custom Note Assignments

If you do not want to use predefined note assignments from a drum map, you can set your pad to use Custom Notes.

When you switch to 'Custom Notes', you can change note assignments by dragging up and down, using the arrows, or double clicking and entering either a note or note number.

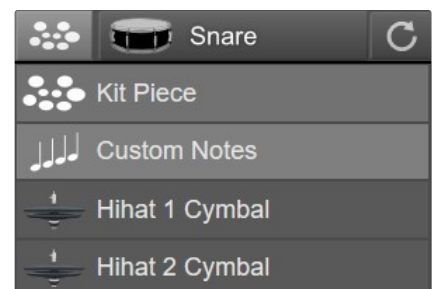

## Setting up a Hihat Controller

Like connecting pads, make sure you connect your hihat controller using a TRS cable. Connect the cable to your hihat controller before plugging it into one of the pedal inputs on the back of the unit.

eDRUMin will attempt to auto detect your hihat set it up automatically. If your pedal isn't working properly after you connect it, you can set it up manually or load a pedal preset if one is available.

### Loading a Pedal Preset

To load a pedal preset, click on the Preset Manager icon. 



After the Preset Manager opens, click on the pedal input. It will turn green and the Preset Manager will list all the factory hihat controller presets.

Roland VH-10 with SD3  
Roland VH-10 with AD2  
Roland VH-10 with BFD3  
Roland VH-13 with SD3  
Roland VH-13 with AD2  
Roland VH-13 with BFD3  
Yamaha HH-65 with SD3  
Yamaha HH-65 with AD2  
Yamaha HH-65 with BFD3  
Roland HD-1 with SD3  
Roland HD-1 with AD2  
Roland HD-1 with BFD3  
Roland VH-12

On the left is a list of the factory hihat presets. If your hihat controller is not listed, you need to set it up manually. Typically all that you need to do is [calibrate](#) its range.

Look [here](#) for information about setting up your hihat controller.

### Setting up your hihat Cymbal

To function optimally, especially if using Hihat Levels mode, the input you use for your hihat cymbal needs to be set to 'Hihat Cymbal'.

If you are using an eDRUMin 10, you will see 'Hihat 1 Cymbal' and 'Hihat 2 Cymbal' because it has two pedal inputs.

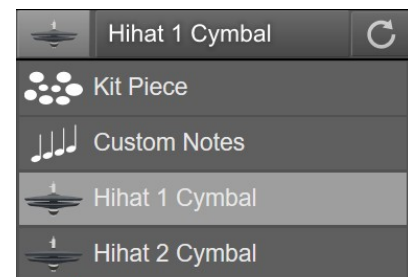

# The Control Application

As your *eDRUMin* has no buttons or controls, you'll need to use the software control application to edit settings on the device.

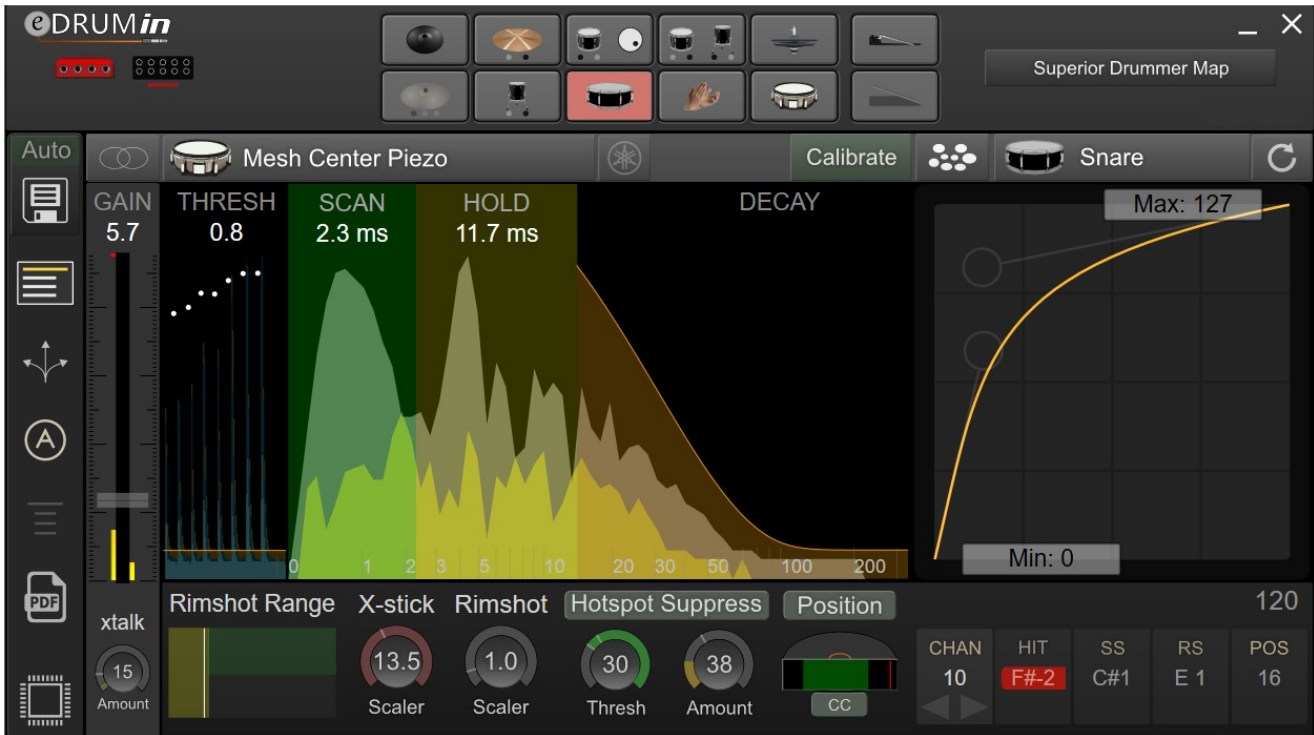

The Control Application doesn't need to be running for the device to work. All the processing and settings are saved on the device itself. By default, any changes you make with the Control Application are saved automatically 5 seconds after the last edit. Make sure you wait a few moments after making a change before unplugging the device.

The Control Application can be resized as you see fit. Just grab one of the corners and drag it to the size you want. The size and position are saved and restored the next time you open the application. Also, you can easily move the application around by clicking and dragging on any empty space in the background of the application or controls.

## The Input Selector

The topmost part of the *eDRUMin* control application is reserved for selecting the device and input you want to edit.



An input can be selected for editing by clicking on its graphic. Assuming the Auto-Select control is on, you can simply hit a pad and it will be automatically selected and ready for editing.

If you have more than one device connected, icons for each device become visible on the right hand side, allowing you to select which device you want to edit. The top row of device icons are for devices that are connected by difference USB ports. Devices plugged in the USB host port of an *eDRUMin* 10 appear on the bottom row.

## Sidebar

The Sidebar gives quick access to pages of controls as well as a few useful settings.

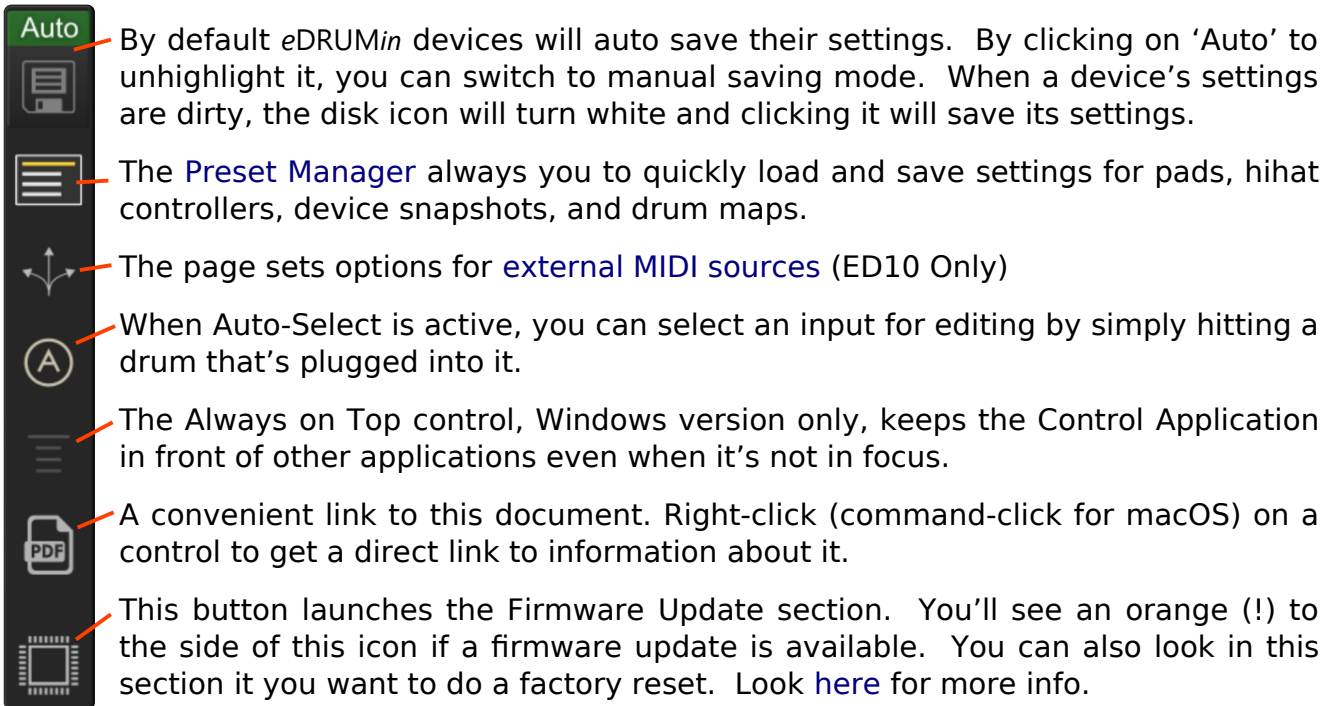

## Trigger Editor

The Trigger Editor is divided into functional groups for configuring the type of pad, adjusting basic scan settings, processing sense data, and controlling the MIDI output. The sections are outlined in the image below.

### Pad / Input Type Settings

### Transient Scanning Controls

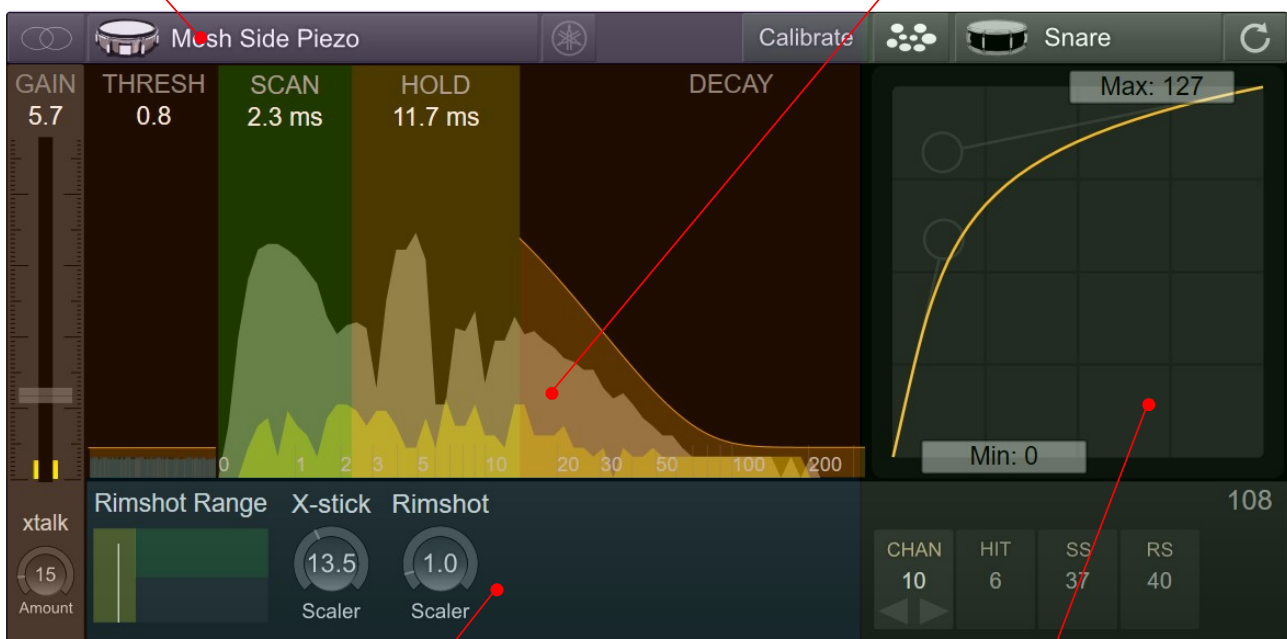

### Sense Settings

### Output Settings

## Pad / Input Type Settings

Whenever you connect a new pad to the device, these are the settings you should adjust first.



### Input Mode

Each input can function as a stereo input (for dual / triple zone pads), mono (single zone pads), and dual mono (two single zone pads connected to a single TRS cable).

### Pad Type Selector

The pad type selector determines how the input will be wired electronically, and which controls are available to edit.

When you press the Pad Type Selector, the following panel appears and you can select the type that best matches your pad.

Click to select Pad Type

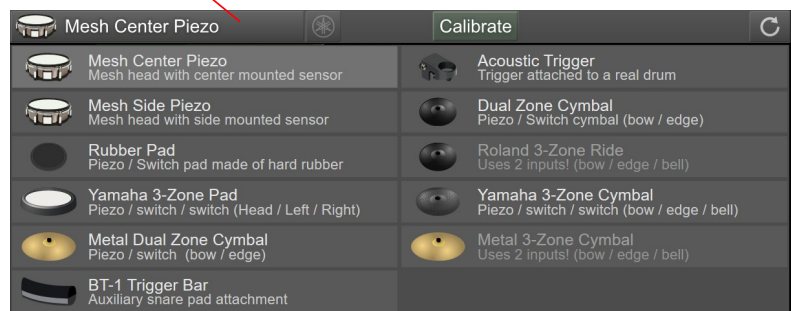

Even before you plug in a pad, you should probably adjust this setting. If the input is set to a piezo / switch pad, but you connect a piezo / piezo pad, the wiring of the input can put strain on the ring piezo. To protect your pads, it's best to unplug the TRS cable from the eDRUMin when changing pads. This allows the eDRUMin to identify the type of pad when it's plugged to detect compatibility issues.

Take a look in the appendix for [wiring diagrams](#).



### Yamaha Wiring Toggle

eDRUMin devices support both Roland and Yamaha style wiring. Some of the [Sensing Controls](#) need to know how the pad is wired in order to work properly. If, for example, the Hotspot Suppression is not working well for you, it could be that you need to toggle this switch. Look at the [Wiring Diagrams](#) in the appendix for more information about how pads should be wired.



### Activate Calibrate Mode

Calibrate mode allows you to set basic scan settings for your pad by simply hitting it with your drum sticks. Look on the following page for more information.

## Calibrate Mode

Calibrate Mode is designed to allow you to quickly setup a pad without needing to fiddle around with controls. You simply turn on Calibrate Mode, hit your pad to calibrate it, and turn it off again when you are done.

Before turning on Calibrate mode, make sure that you have already selected the appropriate pad type.

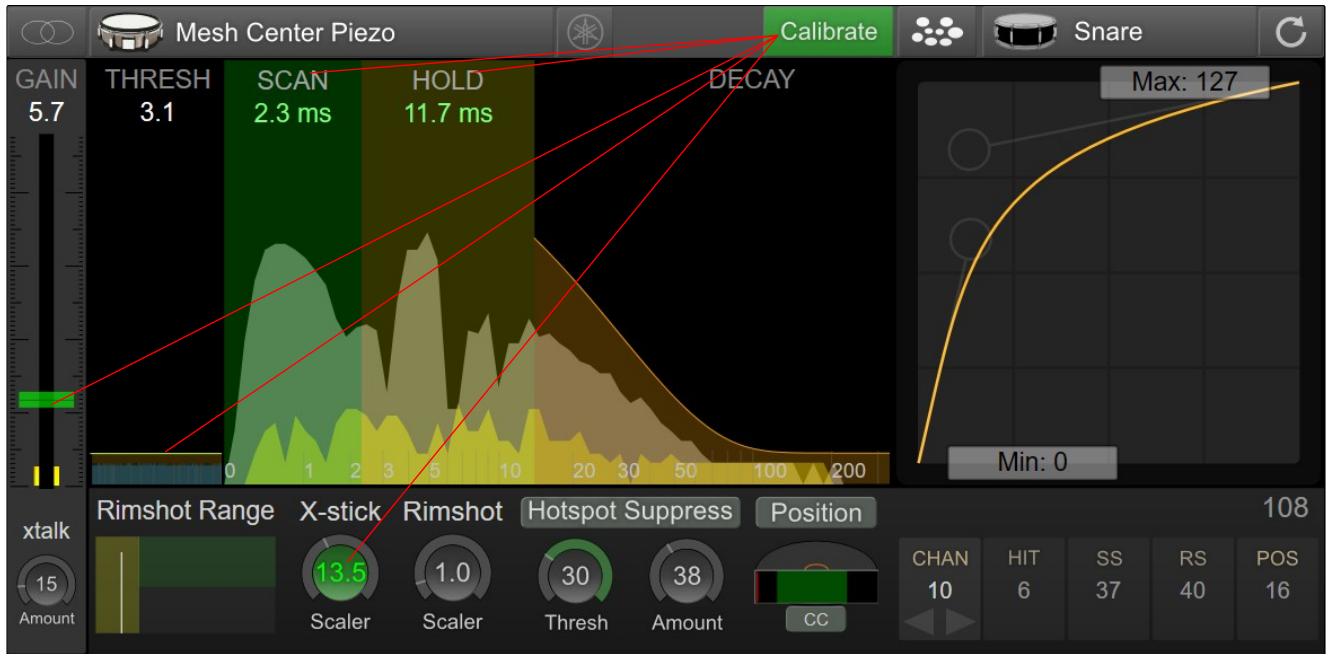

When you first activate Calibrate Mode, the GAIN, THRESH, SCAN, HOLD, and the SCALER controls will be highlighted in green. As you hit the different parts of your pad, the controls are adjusted automatically to provide enough headroom. The harder you hit, the more headroom is provided. You can override the automatic calibration of any control by moving it with your mouse. The control will lose its green highlighting and will no longer be automatically adjusted.

When you are happy with the results, turn Calibrate Mode off to save the settings.

### **Calibrating a Dual Piezo Pad / Trigger**

Start by hitting the pad off-center to calibrate the gain control. Avoid hitting directly over the sensor of the pad, as this can drag down the gain control too quickly.

Next, hit the head of the pad near the edge. This will help get a good calibration for the HOLD control.

Lastly, hit the rim of the pad to calibrate the X-stick SCALER.

### **Calibrating Cymbals**

Begin by hitting the bow to calibrate the gain of the pad. Next hit the edge and the bell to calibrate the SCALERS.

## Transient Scanning Controls

eDRUMin provides a very clear graphical representation of the transients from your pads which makes adjusting controls intuitive and easy.

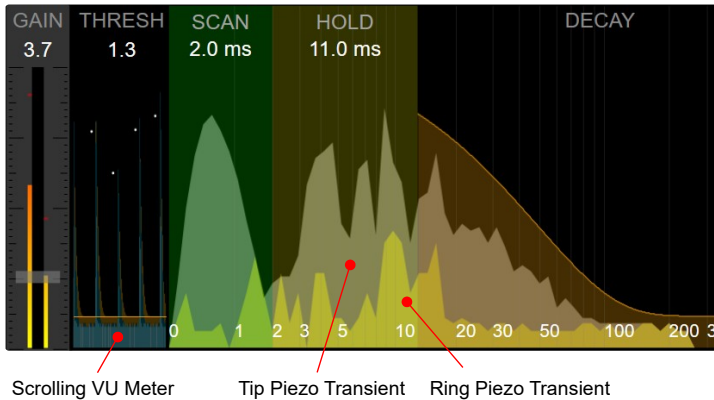

The amplitudes and time scales in the graphics are not linear. The amplitudes are exponentially scaled so that more detail and resolution is available for low amplitudes, making it easier to properly set the Thresh control. Similarly, the time scale is also scaled exponentially to give more detail and resolution at the very start of the transient, making it easier to accurately set the Scan control.

### Gain

The gain control acts as a master gain for the input. Adjusting it affects the velocities of all articulations. To adjust the velocities of individual articulations, take a look at the [Articulation Scalers](#).

Input Gain

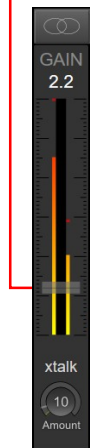

### Thresh

This is the minimum amplitude required to start scanning a transient. Make sure you set it a bit above the noise floor or you will get false triggers, especially when the Control Application is running.

### Scan

Dragging anywhere on the green scan area will allow you to change the SCAN time. You want to keep the SCAN time as short as possible, while ensuring that it covers the major peaks at the beginning of a transient. Scan time adds to the overall latency of the generated MIDI notes, so a compromise between velocity accuracy and note latency has to be made.

**Note:** The [Hotspot Suppression](#) and Positional Sensing features need at least 2.3 ms of scan time to function properly. If the scan time is less than 2.3 ms, they will be disabled.

### Hold

Often a high peak arrives late in a transient. In the graphic above, you'll see that the highest peak actually comes at about 9 ms. Any late peaks need to be covered by the HOLD control or they will cause a second hit to be registered. Keep in mind that long hold times limit the device's ability to trigger accurately during drum rolls and buzz rolls, so don't set it any longer than it needs to be.

### Decay

The last of the transient scan controls is the DECAY control. You need to adjust it to loosely follow the natural decay of your transients. If you are too aggressive (try to follow the natural decay too closely), you could end up with double hits. At the same time, if you leave this control too relaxed, the device's ability to track fast drum rolls will be compromised.



## Crosstalk Cancellation

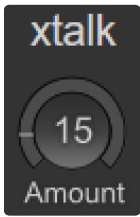

Sometimes vibrations from hitting one pad can travel through a drum stand and into an adjacent pad, registering a hit even though it hasn't actually been hit. This is called crosstalk. The CROSSTALK control is designed to prevent those vibrations from triggering notes.

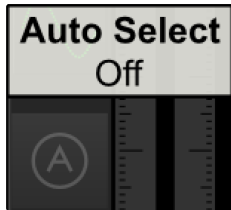

To better see the effect of this control, turn Auto Select off, and watch in the Scrolling View as you hit adjacent pads. The amount of crosstalk cancellation is shown in red. Adjust the CROSSTALK control until the red covers the blue vibrations.

*Vibrations from hitting adjacent pad*

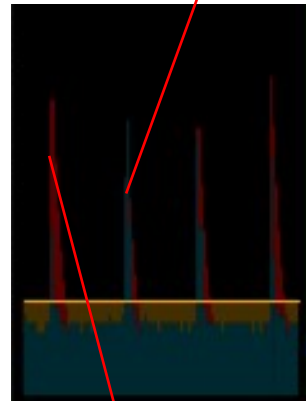

*Crosstalk cancellation applied*

MIDI coming into the device from the USB port is also used in the calculation of crosstalk. If for example you are using 2 *eDRUMin* devices, you can use a DAW environment to route the output of one device into the other and vice versa. This will help prevent crosstalk between the two devices.

*eDRUMin* 10 devices also apply crosstalk cancellation to MIDI coming in from device connected to the USB host port and MIDI in DIN. Look [here](#) for more information about the flow of MIDI between connected devices.

## Articulation Scalers

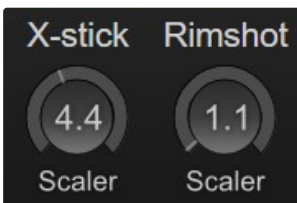

Depending on your input settings (input mode and pad type), one or two articulation scalers will be visible.

For a stereo dual zone pad, the scaler controls are called X-stick and Rimshot. For a 3 zone cymbal (using two inputs or Bell Sense), they are called Edge and Bell.

The velocities for various articulations are calculated based on the GAIN control multiplied by the respective scaler. These settings are automatically calculated when you calibrate your pad using [Calibrate Mode](#).

## Sense Controls

The sense controls that are available depend the [Input Mode](#) and [Pad Type](#) settings. Most of the Sense Control are more advanced controls and you should make sure you have your pad triggering well before adjusting these controls.

### Rimshot Range

The Rimshot Range control allows you to fine tune rimshot detection on dual piezo pads. It consists of an indicator and three sections. The yellow section represents a head hit, the green section represents a rimshot, and the dark grey is for sidestick.

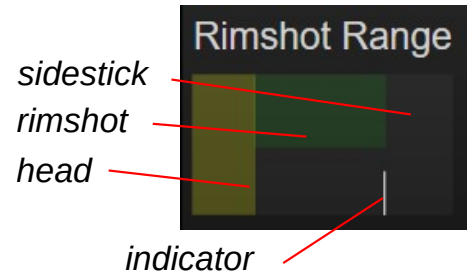

When you hit the head of your pad, the indicator will move to the left, and when you hit the rim, the indicator will move towards the right. The section that lies under the top tip of the indicator determines which articulation is triggered. In the image above, a rimshot is triggered. Watch the position indicator and adjust the size of the sections.

### Hotspot Suppression

One of the annoying qualities of a mesh pad with a center mounted piezo is a sensitive region of the drum head directly over the piezo. The Hotspot Suppression control detects impacts over the piezo and suppresses their amplitudes, evening out the response of the entire playing surface.

The hotspot suppression needs about 2.3 - 3 ms of data to work properly. If you have the [SCAN](#) control set below 2.3 ms, the control will become disabled.

There are 3 separate controls, 'Thresh', 'Amount', and 'Scaler' which is a small knob on the inside of the 'Thresh' control.

Start by adjusting the 'Amount' and 'Scaler' controls to zero. Next, watch the meter of the 'Thresh' control as you hit different parts of the drum head. As you hit the pad around the hotspot, you should see the meter values increase. Set the 'Thresh' control so that hits away from the hotspot register in the dark part of the meter, and hits over the hotspot register in the green part of the meter.

If you find that it difficult to get good separation between the hotspot and area further off center, you can try increasing the 'Scaler' control. This give you better separation, but reduces the ability to suppress low velocity hits on the hotspot.

After you have properly set the 'Thresh', adjust the 'Amount' control to reduce the amplitude of the hits that register in the green part of the meter.



*Outside is Thresh.*

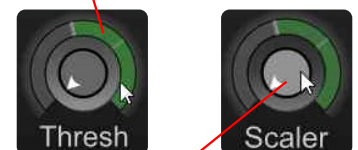

*Inside is Scaler.*

**Note:** Hotspot suppression is designed to work with Roland style pad construction. It works by analyzing the waveform coming from a pad. If the incoming signal coming from your pad is not clean and free of noise, this feature will not work. This is a particular concern for A→E conversions and DIY pad construction. Visit the [eDRUMin troubleshooting forum](#) for more information.

**Note:** When you change drum sticks, you might need to adjust the THRESH control. Generally speaking, heavier sticks will need a slightly lower THRESH, and lighter sticks will need a higher THRESH.

## Edge Sense

When the [Input Mode](#) is set to 'Mono' or 'Dual Input', Edge Sense becomes visible. This control is designed to detect a second articulation for a pad that uses a single piezo. By activating this control, a second 'Note' will appear in the [Note Panel](#).



This feature will not work with all pads. When you hit the edge of your pad, check the meter in the Thresh Control. Does it increase? If it does, adjust the Thresh control so that hits on the center of the pad register below the thresh, and hits to the edge of the pad register inside the green meter.

## Bell Sense

Bell Sense is a feature that's designed to provide reliable and dynamic bell triggering for cymbal type pads using only a single input.

### Supported Cymbals

Currently there are custom Bell Sense algorithms to support the Roland CY-12, CY-13R, CY-15R and CY-8 cymbals. More cymbals can and will be added in the future. If you have a popular cymbal that's not currently supported, contact technical support as it might be possible to add support for it.

**NOTE:** If you have an unsupported cymbal that uses a second input for bell triggering, you can still get 3-way triggering from your pad using the "Roland 3-Zone Ride" pad type, but you will need to use two inputs on the eDRUMin. In this configuration, the second input acts as a 'Bell' input and the triggering will behave much like it does on a Roland module.

### Adjusting the Controls

To enable Bell Sense, click on the 'Bell Sense' label. When the control is enabled, the 'BELL' articulation becomes visible in the Note Panel.

Next, click on the Cymbal Type control to scroll to select the setting that best makes your cymbal.

The Thresh control can be used to fine tune the cutoff between Bow and Bell articulations. When you hit the cymbal, it registers on the meter. Only hits that register in the green part of the meter will trigger the bell articulation. For best results, you should leave the THRESH set at 75.

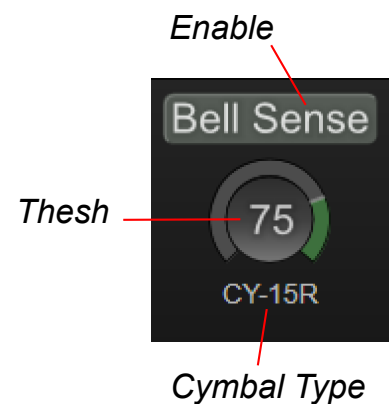

## Positional Sensing

eDRUMin supports positional sensing for cymbals and pads using the 'Mesh Center Piezo' Pad Type. The device can send out a Control Change message (CC) to indicate the position, or a separate Edge Note.

The CC or Note can be set in [Note Panel](#).

To get positional sensing working, you'll need to adjust the Range controls. In the picture on the right, the Range controls are represented by the green bar, and a red line represents the positional measurement.

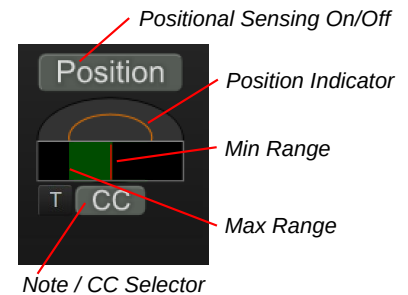

### Setup For Mesh Pads

The Min Range control defines the size of the 'center' region of the pad. When hitting directly in the center of the pad or even slightly off-center, the position indicator should fall to the far right, but as you hit closer to the edge, the red indicator will suddenly jump over towards the right. The Min Range control should be set somewhere between the far left and the point where the indicator just starts to jump to the right.

The Max Range control helps define the sizes of the off-center and edge portions of the pad. As you drag the control further left, the size of the off-center region increases and the size of the edge region decreases.

If using a dual piezo pad, additional control is available by clicking on the 'T' to change it to 'R'. 'R' is for ring, and this control uses information from the ring piezo to improve stability of off center hits. When the red indicator falls into the orange rectangle, the measured position is constrained to be at least 64. Most pads will not benefit from this control and can usually be left with the rectangle set as small as possible.



### Understanding the Positional values

When the pad is hit in the center, the eDRUMin sends a CC value of 0, at the point where the positional sensing begins to register, it sends a CC value between 64 and 127 depending on how close to the edge you hit.

If you are sending a Note instead of a CC, the eDRUMin will send the 'edge' note when the calculated CC value is greater than 95. You can adjust Range Max control to adjust the transition point between 'center' and 'edge'.

### Setup For Cymbals

There are two different positional sensing algorithms for cymbals. The first one is designed to support Roland and ATV cymbals, and the second is a more generic approach that was designed to support the Lemon 18" Ride and may also work with some other cymbals.

You can switch between the two algorithms by pressing the button shown in the image on the right.

The rest of the controls work in a similar fashion as described above.

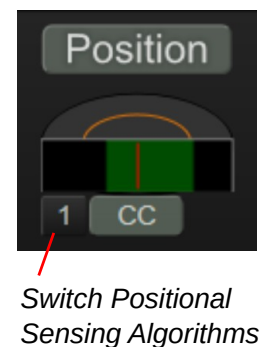



## Note Panel

Depending on how an input is configured, you'll see the MIDI Channel control and up to 4 different Note controls.

If the selected input is set to a 'kit piece', only the CHAN control can be changed and the notes for the various articulation must be changed from the [Drum Map Editor](#). If the input is set to 'Custom Notes', then the for each articulation can be changed directly from the Note Panel and will not change when selecting different drum maps.

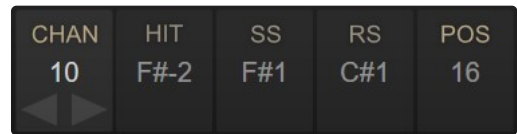
 *Articulation note controls disabled when pad setup as 'Kit Piece'.*



 *Articulation note controls editable when pad set to use 'Custom Notes'.*



## Assigning MIDI Note Values to Articulations

You can input the MIDI notes for individual articulations or you can use the [Drum Map](#) control, described on the following page, to make assignments for all the articulations at once using predefined drum maps.

The controls in note panel can be adjusted by dragging with mouse, using the increment and decrement buttons, or by double clicking and entering a number or note.

**Note:** You can switch showing Notes or Note Numbers by right-clicking on a note control. This will change the setting for all note controls and the setting will be remembered the next time you open the Control Application.

### (CHAN) Channel

This is the MIDI Channel for all the MIDI messages the selected input generates. Unless you have a good reason to change it, you should probably leave it set to channel 10.

### (POS) Positional Sensing

Positional Sensing on *eDRUMin* is communicated by either sending out a Continuous Control (CC) message corresponding to the position of the hit, or as a separate Edge note. corresponding to the position of the hit. Look [here](#) for more information about setting up positional sensing.

### (CHOKE) Cymbal Choking

Roland and Yamaha modules use 'aftertouch' messages for choking dual zone and triple zone cymbals. *eDRUMin* also sends aftertouch messages for choking, but not all modules and VSTs and DAWs support aftertouch messages. For this reason, the device also allows you to specify a MIDI Note for choking your cymbals in addition to sending aftertouch messages.

By default, the choking with notes is disabled. To enable it, click on the 'Choke' control label.

Note that if you are using positional sensing with a cymbal, then sending a choke note will not be available. Choking with aftertouch will function as normal.

Click lable to enable choking with MIDI Notes

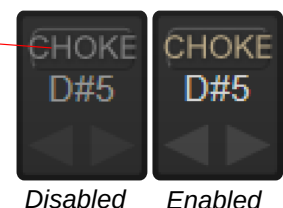

## Load Notes from a Drum Map

If an input is set to use Custom Notes, it can be tedious to input note values, especially when you need to consult a manual to figure out what values to use. Using a drum map, notes for all the different articulations of a single pad can be assigned using a few clicks of a mouse.

First, click on 'Custom Note' button to reveal the drum map and kit piece selectors.

Next, select the drum map you would like to use. Currently there are drum maps for Roland, Yamaha, Drummit, Alesis, BFD3, Superior Drummer 3, Addictive Drums, and Abby Road Drummer.

Lastly, click on the kit piece you want to load notes from. The Map Panel will remain open until you close it so that you can easily and quickly load assignments for all your pads.

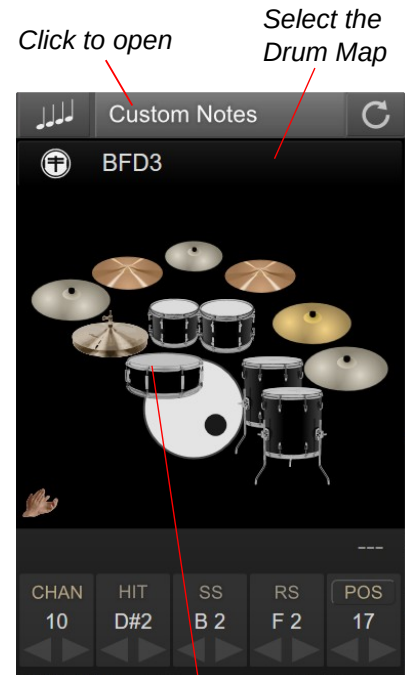

Click to open  
Select the Drum Map  
Click on a drum icon to load its MIDI note assignments

**Note:** Logos and company names are used in a nominative sense to clearly identify drum maps used by those respective 3<sup>rd</sup> parties. eDRUMin has no association with these companies or their products.

## Velocity Curves

Getting an electric drum pad to have the same dynamics as a real drum is a big challenge. Getting realistic drum rolls from a mesh drum pad, for example, can be tricky because the dynamics of mesh and a real drum head are quite different.

To overcome this challenge, eDRUMin devices implements cubic Bezier curves to remap the velocity curve of your hits. The Bezier handles let you draw all kinds of curves while ensuring a smooth transition from the lowest to the highest velocities.

In the image on the left, the curve is being used to make drum rolls on a mesh head feel like a proper drum. After you've gotten your pad triggering well, the Response Curve is the most powerful tool to get it sounding as natural as possible.

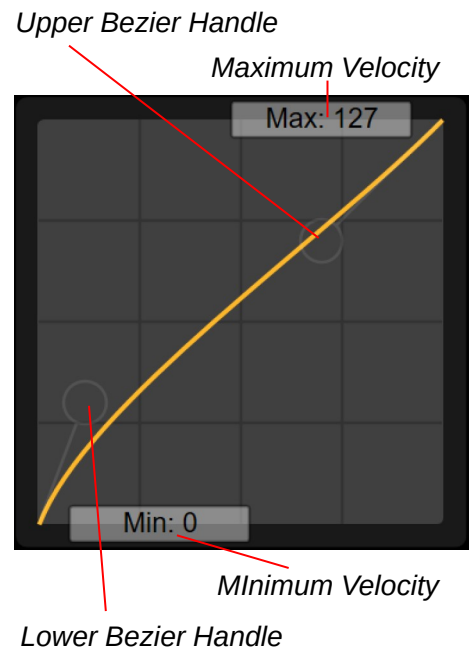

**Note:** By default, the articulations for a single pad all share the same velocity curve. To access independent velocity curves for each articulation, the device needs to be in Advance Mode (described on the following page)

## Advanced Mode

In an effort keep eDRUMin simple to use, some of the more advanced features of the device are hidden by default. You can enable advanced mode by clicking on the eDRUMin logo and selecting the 'Advanced mode' option.

This setting is stored on the device, so each connected device can be in advanced or standard mode. Advanced mode unlocks the following features:

- Note Banks
- Independent velocity curves for each articulation.
- **Impact Mode** for triggering the closed hihat articulation.

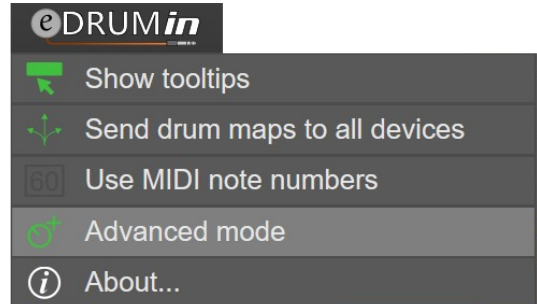

## Working With Note Banks

Each input has four banks where you can save different sets of channel and note assignments. If an input is setup as a Kit Piece, then only the channel setting will be used and note assignments will still be drawn from the drum map.

The currently selected bank can be changed by:

- Clicking on the bank number
- **Using an attached sustain or footswitch**
- **Sending Program Change messages**



Hihat pedals also have four note banks. When the hihat pedal is linked to a trigger input, their selected note banks are also linked. Changing the selected note bank for the hihat cymbal will also change the selected note bank for the hihat pedal and vice-versa.

## Working with Independent Curves

An independent curve can be setup for each articulation of a pad. By default, each articulation shares the same velocity curve as the first articulation.

To enable an independent curve, select the articulation by clicking on its label. Next click on the 'Independent' button.

If a device is returned to 'Standard' mode, all articulations will go back to sharing the same curve as the first articulation.

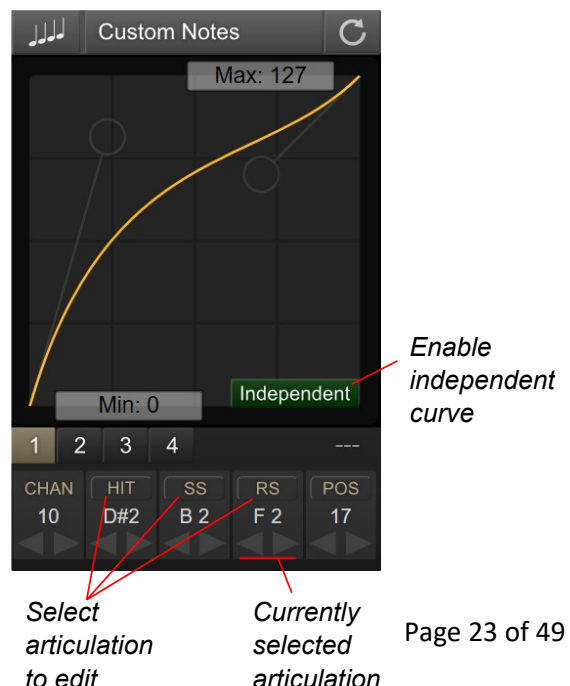

## Using a Roland BT-1

eDRUMin has built-in support for Roland's BT-1 trigger bar. The BT-1 is capable of running in two different modes.

BT-1 setup on a stereo input

Switch between 'Sensor' and 'XTalk' modes



### Sensor Mode

This is the default setup for the BT-1. In this mode, you get the full dynamic range of the trigger bar. This mode is suitable if the BT-1 is not directed connected to another pad.

**Note:** If the BT-1 is connected to an input in 'Dual Mono' or 'Mono' mode, the BT-1 will always operate in sensor mode.

### Xtalk Mode

If your BT-1 is connected directly to another pad, you will likely need to use it in Xtalk mode in order to prevent the BT-1 from mistriggering when you hit the pad it's attached to. In order to use Xtalk mode, the BT-1 must be setup on a stereo input.

### Link to Input

When using Xtalk mode, you can link the BT-1 to another input. This prevents the input from mistriggering when you hit the BT-1. The link another input, follow the diagram below.

When linked to a dual piezo type pad, only sidestick articulations will be filtered out, so the BT-1 and the head or rimshot of the snare can still be simultaneously triggered. For switch based pads, only the BOW or HEAD articulation will be filtered out.

- 1 Make sure the BT-1 is in Xtalk mode.

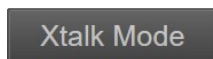

- 2 Click 'Link to Input'



- 3 Select the input to link the BT-1 to.



- 3 When linked and the BT-1 is selected, both inputs will be highlighted in orange.



### Adjusting Crosstalk Cancellation To Linked Input

Once the BT1 is linked, the crosstalk control no longer applies crosstalk cancellation to the BT1, instead, the crosstalk control applies an extra amount of crosstalk to the linked input. The default value of 15 should be good for most setups. Applying too much crosstalk to the linked input will affect the ability for linked pad to accurately trigger when the two pads are hit simultaneously.



# Preset Manager

The Preset Manager allows you to quickly load trigger settings for your pads and pedals. It comes with factory presets for many pads and hihat controllers, but also allows you to create, import, and export your own presets.

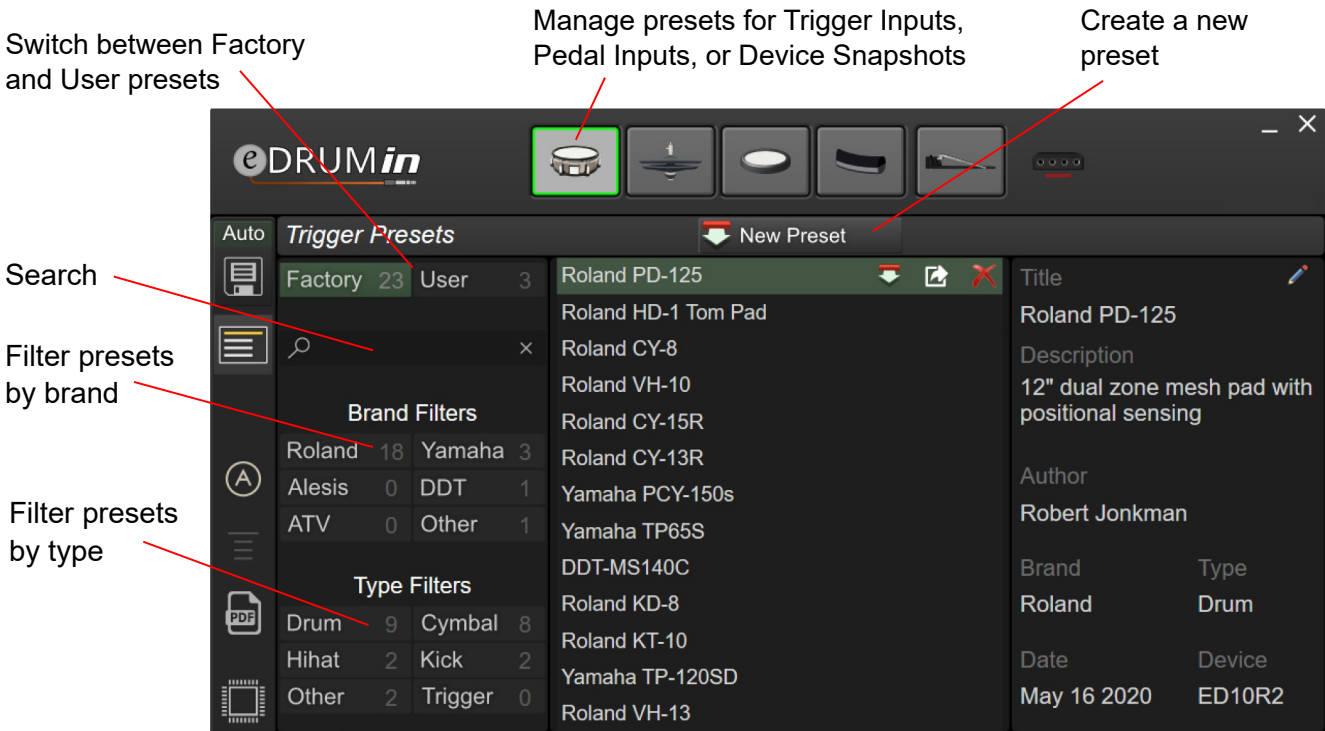

## Preset Types

The Preset Manager allows you to access trigger presets, pedal presets, and device snapshots by clicking on an input or device icon at the top of the UI. The 'Factory' and 'User' buttons switch between presets included presets and ones you create yourself.

## Finding Presets

You can easily find a preset for your pad using the search function or with the Brand and Type filters. Next to each filter is a number that indicates how many presets are associated with that filter. Clicking on an active will remove it.

## Loading a preset

Double-click a preset to load it. Upon confirmation, the preset is sent to the device replacing existing settings. If Auto Save is on, the preset is saved to the device's. If Auto Save is off, power cycling the device will restore your previous settings.

## What Settings Are Loaded

Factory trigger presets include all the settings for a single input except for note assignments. Note assignments remain as they were before the preset was applied. Factory pedal presets, on the other hand, *do* include note assignments.

When loading a user preset, you can choose what settings to send to the input.

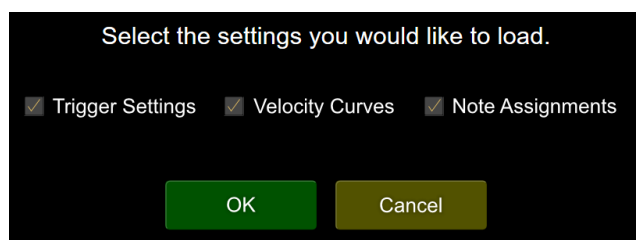

## Creating User Presets

A new user preset is created by selecting an input and clicking on the  New Preset icon.

The settings from the device are then downloaded and stored to your computer. A dialog box is displayed and allows you to set metadata for the preset.

Carefully setting the metadata is highly recommended, especially if you plan to share your presets with others.

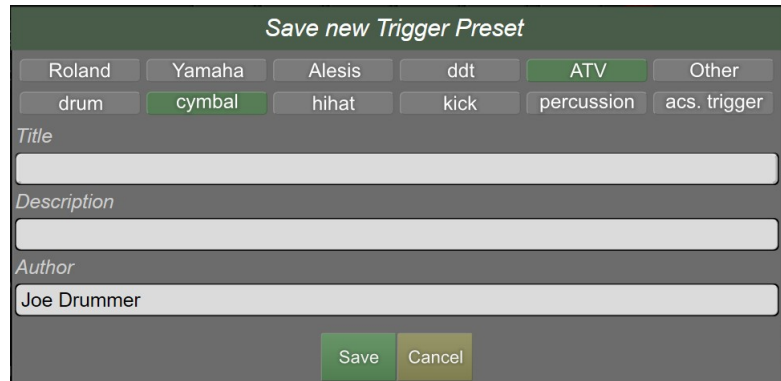

The dialog box titled "Save new Trigger Preset" features a grid of buttons for selecting a device and input. The selected device is "ATV" and the input is "cymbal". Below the grid are three text input fields for "Title", "Description", and "Author". The "Author" field contains the text "Joe Drummer". At the bottom right are "Save" and "Cancel" buttons.

## Working with User Presets

When you select a user preset, a set of icons appear to the right.

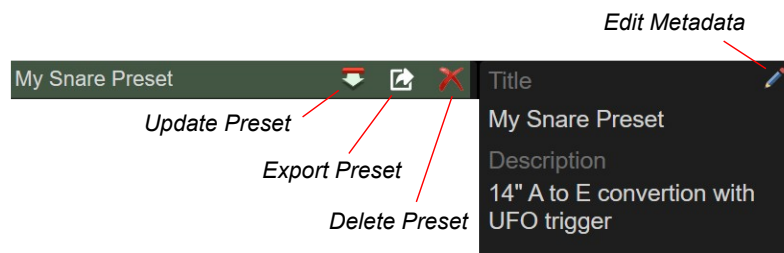

### **Updating a Preset**

When you click this icon, the settings for the selected input or device are re-downloaded and stored into the preset, overwriting the previous settings. The metadata for the preset is preserved.

### **Exporting a Preset**

This exports the preset, which has a file extension .edp, to your desktop. A notification showing the name of the file is displayed. You can then backup that preset or share it with others.

### **Editing Metadata**

Edit the metadata for a preset without changing the contents of the preset itself.

### **Deleting a Preset**

Click to delete a preset. A confirmation dialog is displayed.

## Importing Presets

A preset can be imported into your user presets by dragging and dropping an .edp file onto the Preset Manager. A notification is displayed and the preset is added to the list of User Presets.

# Drum Map Editor

Drum maps allow your eDRUMin to easily switch between triggering between different hardware / software applications.

eDRUMin comes with several factory drum maps, but users can also create and edit their own maps with the Drum Map Editor which is integrated into the Preset Manager. Click on the drum map button, shown right, to view, load, or edit the drum maps on your system,

Open the Drum Map Editor



To start editing a drum map, either click  to create a new user drum map from the one already stored on your device, or duplicate a factory preset.



When you duplicate a factory preset, it's automatically placed in your user presets and selected for editing.

After editing a drum map, you must save it by clicking on the white save icon in the top right hand corner of the editor.

Once saved, double-click on the drum map to send it to the device. If you have more than one device connected to your system, the map will be sent to whichever device is currently selected.

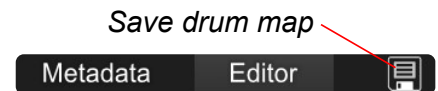

You can have drums sent to all connected device by clicking on the eDRUMin logo and selecting 'Send drum maps to all devices,' turning its icon green.

Click to show options menu

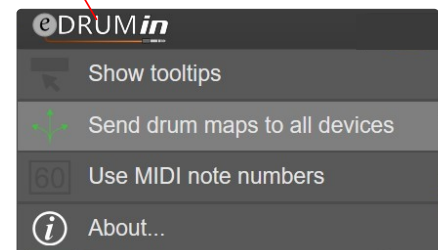

After enabling this option, loading a drum map will send it to all eDRUMin devices connected to your computer.

A drum map is broken up into two pages of kit pieces (32 total) and a page for hihat pedal / cymbal.

## Page 1 Kit Pieces

Each kit piece has four notes associated with it. The labeling of the notes depends on whether the image associated with the kit piece is a pad, cymbal, or percussion.

The first three notes are the standard 3 zones that most pads and cymbals can trigger, but the forth note's function varies depending on an input's settings.

If the input supports positional sensing, then this will correspond to the positional CC that the pad should use.

If the pad type is a cymbal and the choke label is enabled, then this note represents a choke note that is sent along with aftertouch. Look [here](#) for more information about enabling choking with notes.

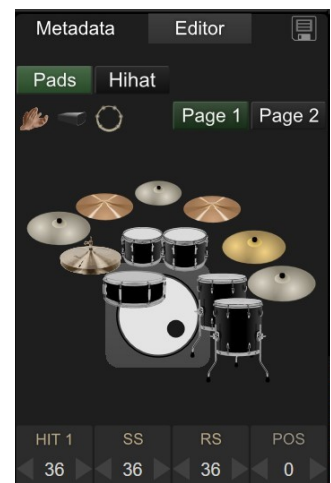

## Page 2 Kit Pieces

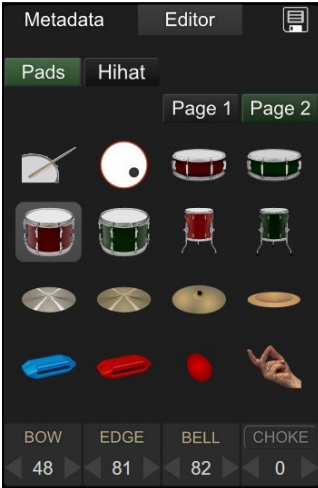

While the page 1 kit pieces will be sufficient for 95% of users, Page 2 kit pieces are for those with more complex setups.

Page 2 lets you define an additional 16 kit pieces, and unlike the page 1 which has predefined images, the images for kit pieces on page 2 can be changed.

To change a kit piece's image, right click on it and select an image from the list of available images.



## Hihat Pedal / Cymbal

The hihat section defines the notes that pads set to 'Hihat Cymbal' will trigger when the hihat is in Levels Mode. If the hihat is in CC Mode, then pads set the 'Hihat Cymbal' will trigger the notes defined by the hihat kit piece from Page 1 kit pieces.

By clicking on the various levels, you can adjust the notes that will be played for each level. You can drag and drop levels onto each other to quickly copy assignments.

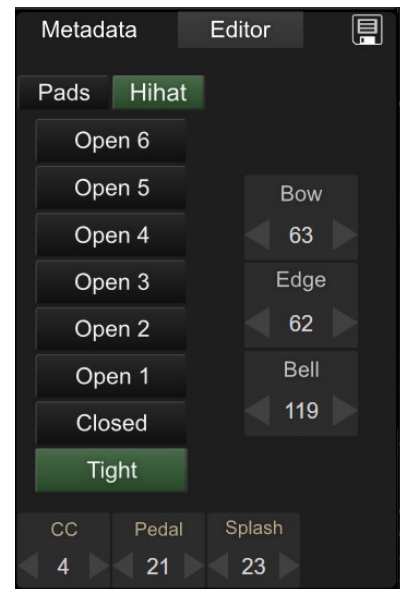

## Drag and Drop

Drag and drop is supported within a drum map, and also between drum maps.

For example, you can drag one kit piece onto another to copy its note assignments. The same goes for hihat levels. You can drag one hihat level onto another to copy note assignment.

You can also drag kit pieces, hihat levels, all pads, and all hihat settings between drum map presets. When you do this, the target preset is updated and saved immediately.



*Copy notes by dragging one kit piece onto another.*

## Pedal Editor

The pedal input(s) on the back of the *eDRUMin* supports a wide array of pedal types including hihat controllers, expression pedals, sustain pedals, and footswitches.

You can open the pedal editor by clicking pedal input icon at the top of the UI.

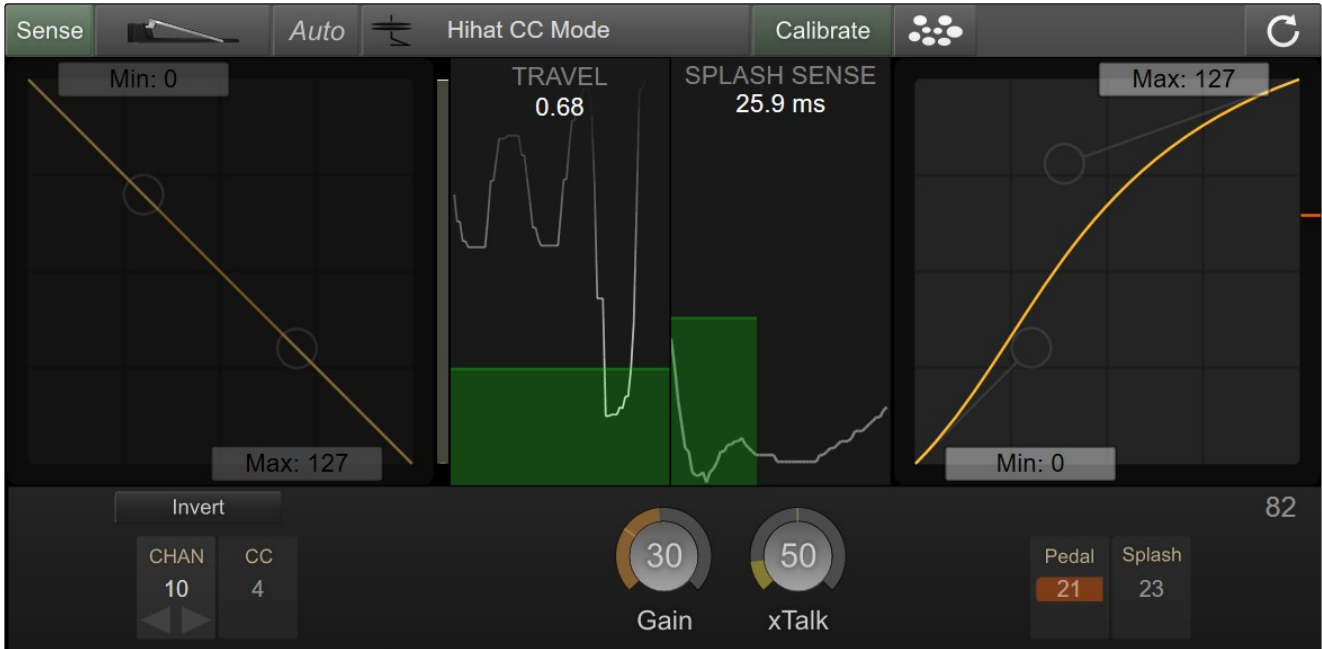

## Pedal Type and Pedal Sensing

The pedal input will perform different functions depending on the type of pedal it is setup for. You can see that the hihat pedal is currently selected in the image on the right.

*Pedal Sensing On / Off*



*Current Pedal Type*

In order for the pedal sensing to work properly, always connect the cable to your pedal before connecting the cable to the *eDRUMin*.

Most pedals can be automatically detected and set up. Expression pedals and hihat controllers will be configured as hihat controllers, while footswitches and sustain pedals will be setup to perform bank changes.

Yamaha hihat controllers will initially be detected as footswitches, but will immediately switch to a hihat controller when the hihat pedal is pressed.

Some hihat setups will not be properly detected. Here are specific instructions for the [Roland VH-12](#) and [Hall effect sensor](#) based pedals.

## Hihat Controllers and Expression Pedals

When a hihat or expression pedal is connected, it is automatically setup to send out CC messages for the position of the pedal, and velocity sensitive closed hihat notes and splash articulations.

Before adjusting settings for your hihat, make sure it is [properly setup on its stand](#).

### Calibrating Your Pedal

You should calibrate your pedal even it seems to working fine when you first connect it. eDRUMin auto calibrates the pedal and won't lock in calibration settings until you go through the calibration process.

Click Calibrate to reveal the calibration range. Take the pedal through its full range of a motion. When done, click the calibrate control again to store the settings.

The calibration can be overridden by dragging either side of the green range indicator.

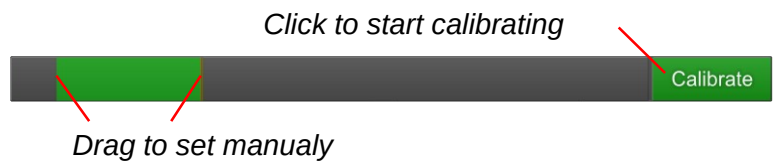

If you are using a hihat on a hihat stand, making adjustments to the tension of your hihat stand and clutch position will likely require you to re-calibrate your hihat controller for optimal results.

### Modes for Expression Pedals and Hihat Controllers

By default expression pedals and hihat controllers will function as hihat controllers in CC mode as shown in the image below.

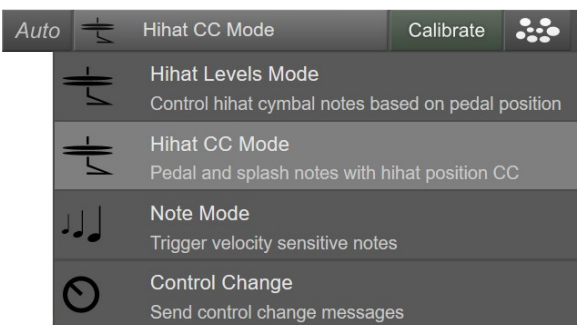

By clicking on the Mode control, you can change what the pedal does.

Only the two Hihat Modes are discussed in this manual. The other mode are more intuitive and if you want more information about them, please consult the [MIDI Expression User Manual](#).

### Note Source

Like trigger inputs, a hihat pedal can get its note assignments from the device drum map, or it can be set to 'Custom Notes'. When set to Custom Notes, the CC, Pedal and Splash are independent of the device drum map.

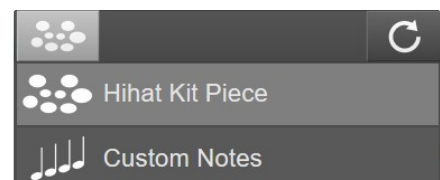

This setting also affects any trigger inputs that are set 'Hihat Cymbal'. If this is set to 'Custom Notes', than those pads that are set to 'Hihat Cymbal' will also use their 'Custom Note' assignments and not the notes defined in the drum map.

## CC Mode vs. Levels Mode

A hihat controller has two basic functions. First, it communicates the position of the hihat pedal so that hihat sounds can vary in terms of their openness, and second it triggers velocity sensitive pedal and splash notes when you press the pedal all the way down.

CC Mode and Levels Mode handle triggering pedal and splash notes in the same way, but differ in the way they handle communicating the hihat position.

### CC Mode

CC Mode sends out a CC message corresponding to the position of the pedal. Many applications can use this CC to determine which hihat sound to trigger.

The Curve control allows you adjust the dynamics of the CC message values.

It can be turned on and off by simply clicking in the background of the control.

You use the Bezier handles to adjust how fast the hihat opens and closes when you press the pedal.

The MIN control allows you to simulate a hihat, clutch, allowing you to restrict the amount of openness when the pedal is fully released.

*Pull down the min to simulate hihat clutch adjustments.*

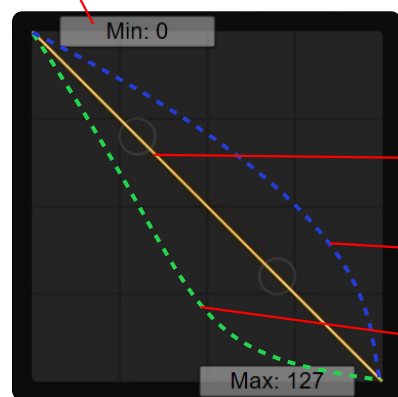

*Hihat opens normally.*  
*Hihat opens more quickly.*  
*Hihat opens more slowly.*

### Levels Mode

With Hihat Levels Mode, eDRUMin takes more control over which hihat sounds are triggered by using different sets of MIDI notes for the hihat cymbal depending on the position of the pedal. This mode is suitable if you require more control over the transitions between your hihat sounds or for applications and devices that do not process CC4 messages.

To work properly, the input your hihat cymbal is connected to must be set to 'Hihat 1 Cymbal' or 'Hihat 2 Cymbal, depending on the pedal input you are using.

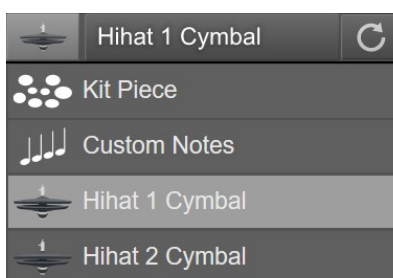

*Set the currently selected level*

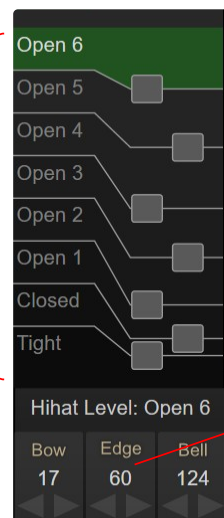

*Adjust transitions between levels*

*Set or view MIDI assignments for selected level.*

## Adjusting the Responsiveness Closed Hihat Notes and Splashes

Before you adjust these controls, make sure your hihat controller is properly calibrated.

### Travel

The travel control determines where along the pedals travel a note can be issued. In the image on the right, the line traces the position of the pedal over time. The pedal must pass into the green area in order for a note to be generated.

If you are using a two piece hihat like a Roland VH-13, make sure the green area is a little above the point where the two hats come together.

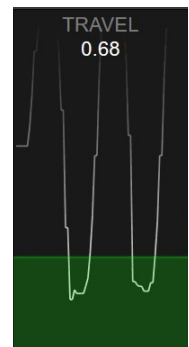

### Splash Sensitivity

Any time a pedal note is triggered, a splash note can also be triggered if the pedal reopens quickly enough. The height and width of the green box in this control is used to adjust the sensitivity.

A splash note will be triggered the moment a pedal transient travels up and out of the box like it does in the picture on the right. The width of the box sets the maximum time window in which a splash can be triggered, and the height determines how far the pedal must reopen.

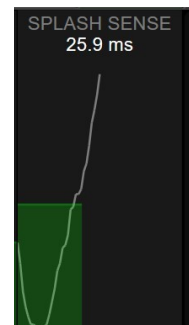

### Gain

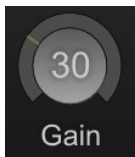

This Gain control compensates for how fast your pedal changes values. The faster your pedal moves, the lower you need to set the Gain Control. Hihat controllers typically work best with low gain values and Expression pedals work best with high gain values.

### xTalk



If you are using a hihat setup where pressing down on the hihat pedal causes the hihat cymbals to vibrate, you can use the xTalk control to prevent those vibrations from causing false triggers. The control's meter measures the vibrations of the hihat trigger when the pedal generates a note. Set the value of the control above the meter.

### Velocity Curve

The velocity Curve control allows you to shape the velocity response of pedal and splash notes. It works exactly like the one for trigger inputs. Look [here](#) for more information.

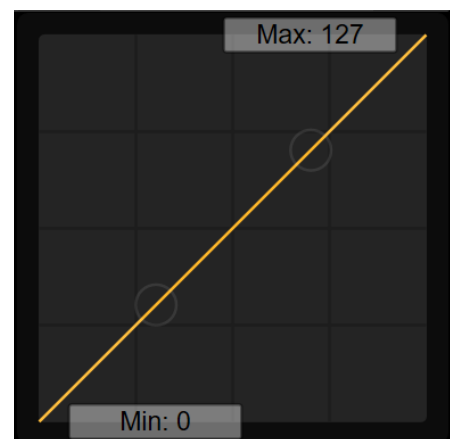



## Impact Method (Advanced Mode)

If your device is in [Advanced Mode](#), you can use the 'Impact' method of triggering close hi-hat pedal notes. With this method, the velocity of pedal notes is determined by the vibrations of the hi-hat cymbals as they come together when the hi-hat pedal is pressed. It's very important that your hi-hat trigger settings are optimal. Poor choice of threshold and hit decay values will affect the ability to accurately trigger the closed hi-hat pedal articulation.

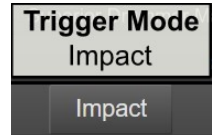

### Hihat pedal Thresh

This needs to be set very carefully. Setting it too low will cause false triggering when your hi-hat cymbals move, and setting it too high will result in missed pedal events.

To make adjustments, use the yellow meter. The thresh setting will be optimal when the meter shows 5% to 20% while pressing the pedal to trigger the close hi-hat pedal note, like it does in the image on the right.

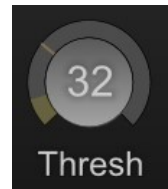

### Scaler

The scaler control is used to determine the velocity of a close hi-hat pedal articulation. Increase the value of the control to get higher velocity notes. The meter in this control displays the final velocity of the notes.

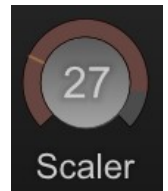

## Advanced Hihat Options

For most users, these options should be left unchecked. They are advanced options that most users do not need to be concerned with and can produce unwanted results.

### Fast Stepping

In some drum triggering software applications, most notably Superior Drummer, rapid up and down movements of the hi-hat pedal can cause strange audible artifacts due to the way it transitions between hi-hat samples.

One way to remove these artifacts is to stop sending CC position values for a short period of time after a closed pedal note is produced. Checking this box will do exactly that.

### CC With Hit

Superior Drummer will attempt to transition between hi-hat samples whenever the hi-hat pedal is moving. Most people regard this as a feature as it provides a more natural sounding hi-hat in most situations, but others do not like the subtle artifacts that it produces. By checking this checkbox, *eDRUMin* will only send the hi-hat positional CC just before a hi-hat note is sent. This effectively prevents the Superior Drummer from being able to transition between hi-hat samples at all.

## Setting up VH-12 and Hall Effect Sensors

### Roland VH-12

Most Roland Hihat controllers can be sensed automatically, however the VH-12 is a bit of a unique beast. To get it to work properly, use the VH-12 factory preset or set it up manually as described below.

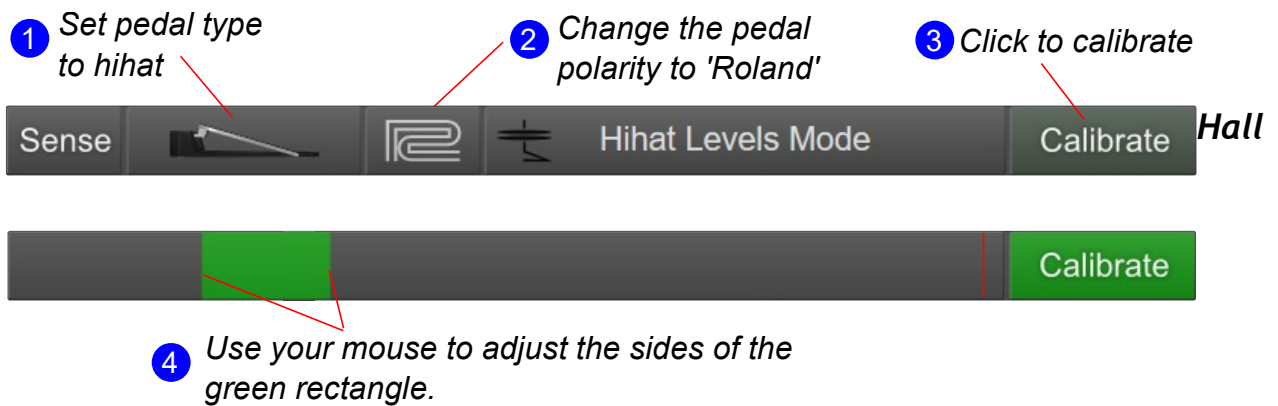

### Effect Sensors

eDRUMin is compatible with hall effect sensors. While the pedal sensing feature can properly detect some Hall effect sensor setups, you will likely need to set things up manually.

#### Self-Powered

If your Hall effect sensor is self or externally powered, the pedal type needs to be set to hihat and the polarity set to Roland, just like for the VH-12 mentioned above.

#### Requires Power From Jack

If your Hall effect sensor needs power from the eDRUMin, the pedal input type needs to be set to 'Expression'. The POLARITY control determines the function of the tip and ring connections.

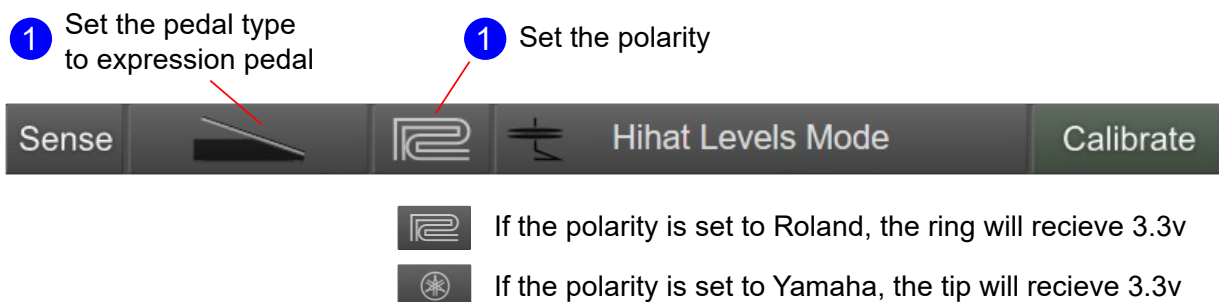

Look [here](#) for a recommended Hall effect sensor and wiring diagram.

## Sustain Pedals and Footswitches

When a sustain or dual footswitch is plugged into pedal input of the eDRUMin, the pedal is automatically configured to change the Note Bank for the currently selected input, however for it to work properly, your device will need to be in [advanced mode](#).

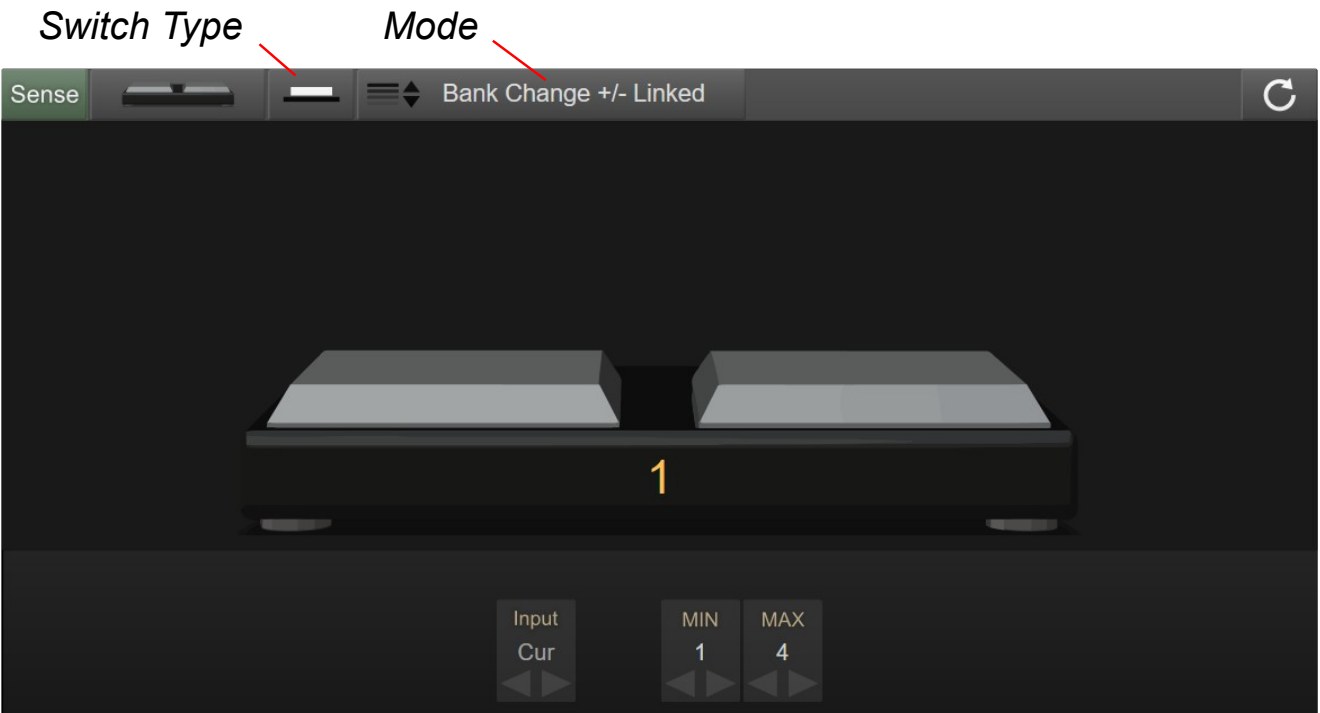

### Using a Latching Type Footswitch

By default, the input is setup to be used with momentary type switches. If you are using a latching style footswitch, change the SWITCH TYPE to 'latching'

### Modes for Sustain Pedals and Footswitches

A sustain pedal or footswitch doesn't have to be used for Bank Changes. These types of pedals are able to send many kinds of MIDI messages. You can change the MODE of your pedal clicking on the MODE button.

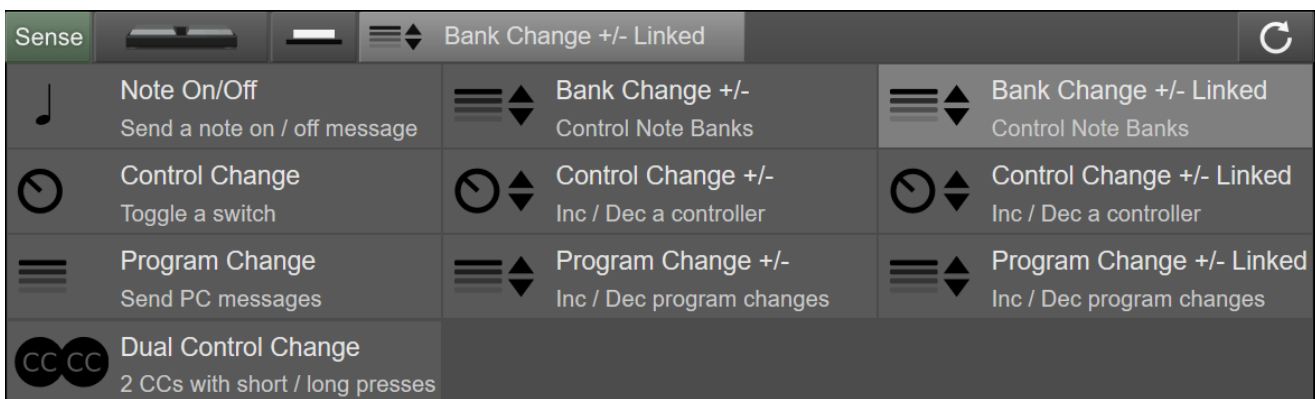

As most eDRUMin users will only be using the Bank Change mode, that is the only mode described in this manual.

For more information about the other available modes, consult the [MIDI Expression Manual](#).

## Using a Pedal for Bank Changes

When your device is in [Advanced Mode](#), each input has 4 banks of MIDI notes associated with it. These banks can be controlled using a pedal plugged into the pedal input on the back of your device.

When you attach a footswitch or sustain pedal, it is automatically setup to perform Bank Changes for the selected input (the the pad that was last hit). Press the pedal quickly to select the next bank. Do a long press to select the previous bank.

**Note:** For a dual fooswitch the two buttons are linked by default. This means that one button will select the next bank and the other will select the previous.

### Bank Change Logic

There are three ways you can change banks. You can send bank changes for all inputs at the same time, to a single input, or to the currently selected input.

Use the INPUT control to select which input(s) to send Bank Change messages to.

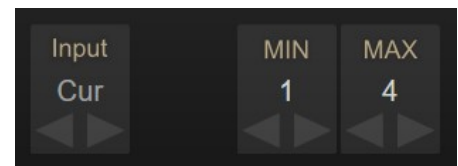

#### Send to Currently Selected Input

The lowest value is 'Cur' and means the bank change messages will be sent to the currently selected input. The idea is that you hit a pad to 'select' it, and then press the pedal to change its bank. If you have another eDRUMin connected to the USB host port, the bank change will only be sent to the selected input of the selected device.

#### Send to a Single Input

Perhaps you only need to change to bank of a specific input without needing to worry about whether it's selected or not. Using the input values 1-4 (ED4) or 1-10 (ED10), you can send bank change messages to specific inputs. When sending to a single input, the bank change will never be sent to other eDRUMin devices connected to the USB host port.

#### Send of All Inputs

Use the greatest setting 'ALL' to send the bank change messages to all inputs, including all the inputs of any devices connected to the USB host port of an eDRUMin 10.

Note: Hihat controllers also have 4 banks associated with them. If your hihat controller is [linked](#) to a trigger input, the banks for the hihat pedal will change whenever the bank for the input it's linked to changes.

### Bank Select Range

The MIN and MAX controls allow you to specify the range of banks to use. The bank selection wraps around so if you increment past MAX, it'll wrap around to bank MIN and vice versa. So if you set the MIN to 1 and MAX to 2, pressing the button on your pedal will alternate between those two banks.

## MIDI Monitor

The MIDI Monitor allows you to see the MIDI data moving through the device allowing you to see where it originates, and where it goes.

Click the  icon to show the MIDI Monitor.

It has a 1000 event history and is scrollable. To function efficiently, messages do not arrive in real-time. They are buffered and sent in packets and can arrive up to 100ms after the actual MIDI event.

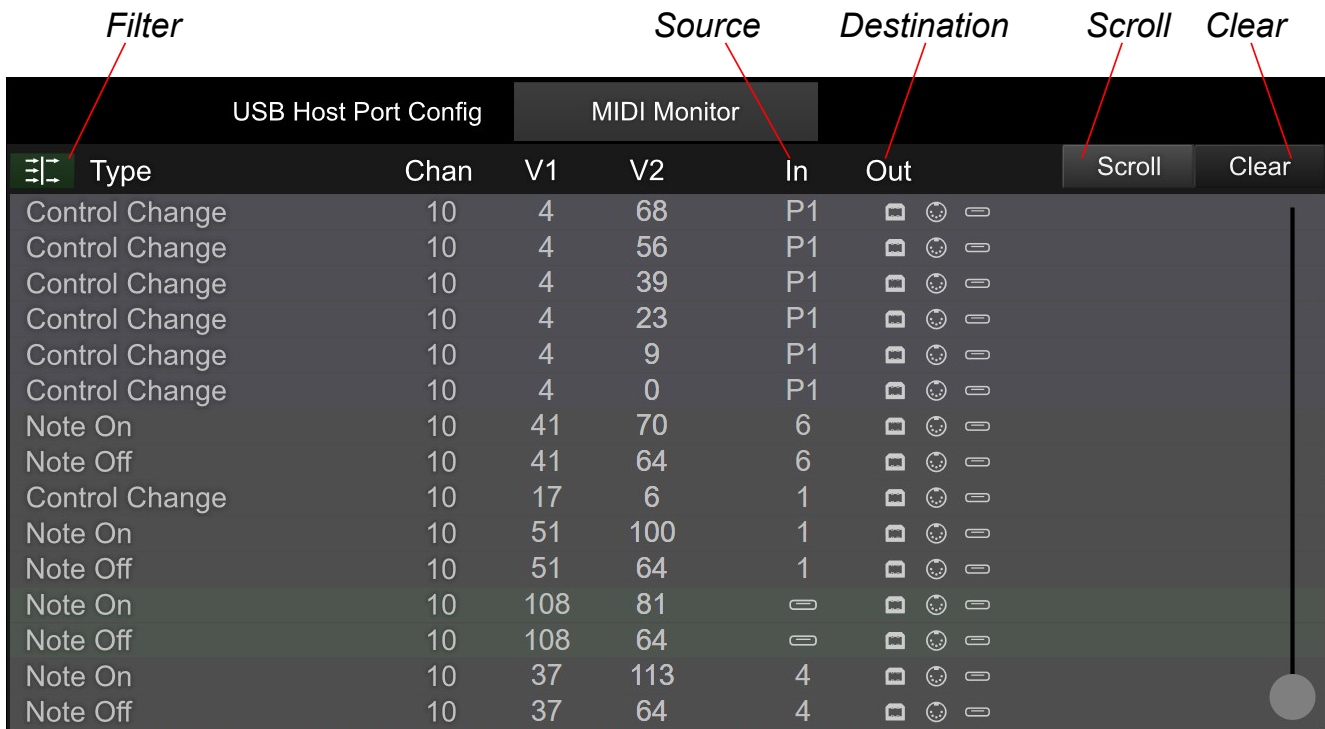

The screenshot shows the MIDI Monitor interface with the following components labeled:

- Filter:** A filter icon (three horizontal lines) in the top left corner.
- Source:** Labels 'Source', 'In', and 'Out' pointing to the columns for message origin and destination.
- Destination:** Labels 'Destination', 'In', and 'Out' pointing to the columns for message origin and destination.
- Scroll:** A 'Scroll' button in the top right corner.
- Clear:** A 'Clear' button in the top right corner.

Type	Chan	V1	V2	In	Out	Scroll	Clear
Control Change	10	4	68	P1			
Control Change	10	4	56	P1			
Control Change	10	4	39	P1			
Control Change	10	4	23	P1			
Control Change	10	4	9	P1			
Control Change	10	4	0	P1			
Note On	10	41	70	6			
Note Off	10	41	64	6			
Control Change	10	17	6	1			
Note On	10	51	100	1			
Note Off	10	51	64	1			
Note On	10	108	81				
Note Off	10	108	64				
Note On	10	37	113	4			
Note Off	10	37	64	4			

### Source and Destinations

This indicates where a MIDI message arrives from and where it goes to. Trigger inputs are labeled 1-10, pedal inputs are P1 or P2, is device's USB port, is the MIDI DIN, and is the USB Host port.

The background of events are also color coded by their source. Trigger input messages are grey, pedal input messages are bluish grey, USB host port messages are green, USB MIDI messages are orange, and DIN MIDI messages are purple.

### Scroll

When you use the mouse wheel to scroll through the events in the monitor, the auto-scroll button gets deactivated to prevent newly arriving events from changing the current position in the log. Activating 'Scroll' will then jump to the end of the list allowing you to see any new events.

### Filter

On by default, this filters out Active Sensing, MIDI Clock, and Note off messages. The vertical bar in the middle of the icon will flash when messages are actively being filtered.

## eDRUMin 10 USB Host Port and MIDI Ports



The eDRUMin 10 comes with a USB host port and full-size MIDI Din ports for interfacing with other gear.

The USB Host port allows users to connect additional eDRUMin devices or USB MIDI devices and have them function as an aggregate device, complete with crosstalk cancellation between devices.

Using a USB hub, the eDRUMin 10 supports connecting up to four additional devices. The USB Host port can only supply up to 500mA of power. If you are using a hub and require more than 500mA, be sure to use a powered hub.

### The Flow of MIDI Messages

By default, MIDI generated by each device is forwarded to all the other connected devices.

Imagine that we have an eDRUMin 10 connected to a computer via USB. Additionally we have an eDRUMin 4 and a Yamaha drum module connected via a USB hub to the eDRUMin 10 USB host port.

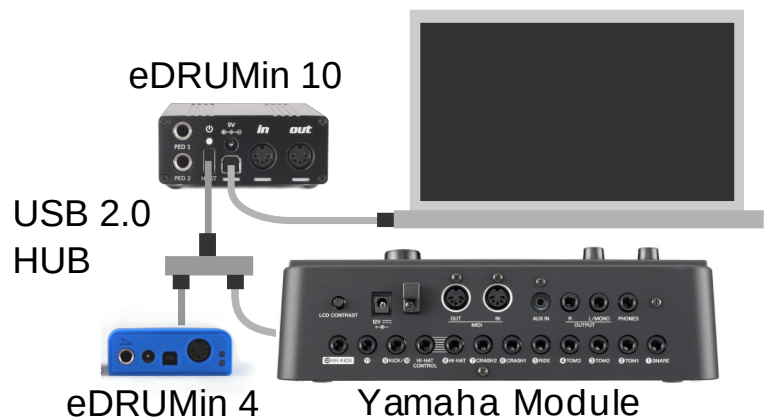

The following statements describe what happens to the MIDI.

1. The MIDI from the eDRUMin 10, the eDRUMin 4, and the Roland module are processed by the eDRUMin 10.
2. Crosstalk cancellation is applied to the MIDI to ensure unintentionally triggered MIDI notes are filtered out.
3. The filtered MIDI from each device is then forwarded on to each of the other connected devices.

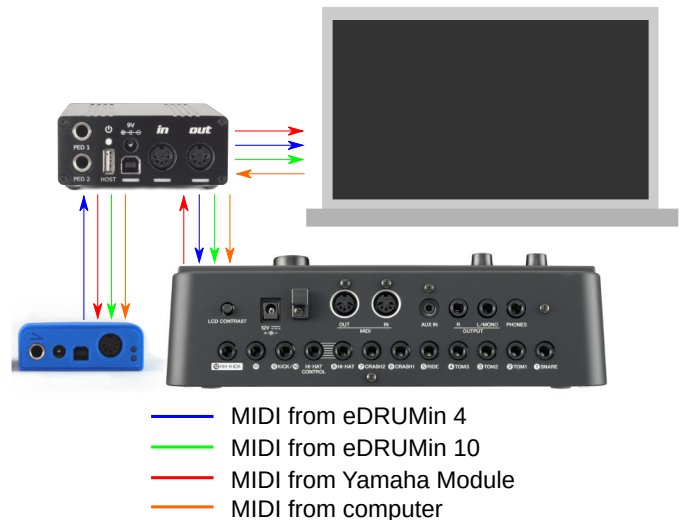

This behavior allows the eDRUMin 10, eDRUMin 4, and the Yamaha module to act as one aggregate device with respect to the computer. At the same time, the eDRUMin 10 and eDRUMin 4 can simultaneously trigger sounds on the Yamaha module.

If connecting a Roland drum module with Local Control disabled, see the next page to ensure that the MIDI it generates is sent back to itself.

## Processing External MIDI

This page allows you to adjust crosstalk cancellation for external sources of MIDI and adjust MIDI routing settings for individual sources.

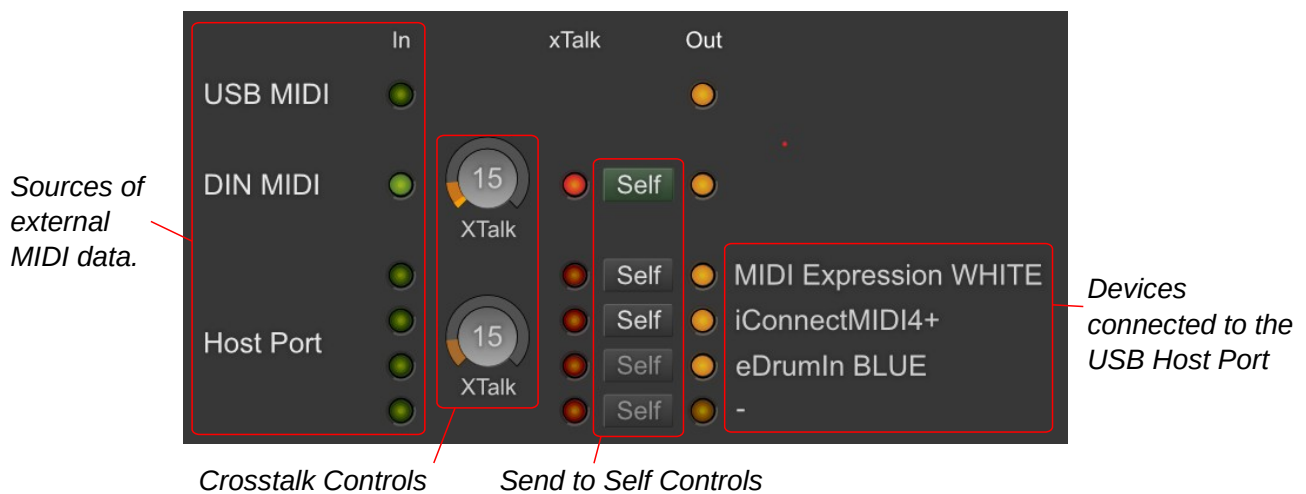

### Crosstalk Cancellation

When pads connected to a common structure are processed by separate devices, crosstalk can be an issue. The tom pad in the image on the right is connected to an input of an eDRUMin 10 and the cymbal is connected to an eDRUMin 4, which is connected to the ED10 via the MIDI DIN IN port. When the tom pad is hit, the ED4 also triggers a note because the two pads share a common structure.

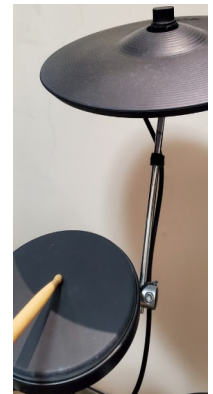

Indicated MIDI note was filtered.

This crosstalk can be filtered out using the crosstalk cancellation controls.



When we hit the tom pad, the MIDI DIN In LED lights indicating MIDI activity from the ED4. The meter in the xTalk control lights up indicating that the ED10 detected crosstalk. Because the xTalk control is set higher than the measured crosstalk, the Note On/Off messages are filtered and the red led lights up.

Amount of crosstalk cancellation needed to filter note

In this example, we can see that we can safely reduce the crosstalk control substantially. Typically pads connected to separate devices are physically isolated, so xTalk can be turned all the way down.

### Self Send To Self

By default, when a device connected the eDRUMin generates MIDI data, that data is sent to all other connected devices, but it is not back to itself. This is done to prevent the possibility of creating MIDI feedback loops. In some circumstances you might want the MIDI to be returned to the source. If, for example, you are using a Roland module and have "Local Control" disabled, you will need to send the MIDI back to the source in able to hear the sounds back on your module. Enable the 'self' button for a MIDI source to have its crosstalk processed MIDI sent back to it.

# Updating Firmware

The *eDRUMin* firmware is periodically updated to add new features or fix bugs. The latest firmware for *eDRUMin* is always included with the *eDRUMin* Control application.

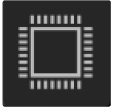

The firmware can be updated or changed by clicking on the Firmware Update icon located at the bottom of the sidebar. Please note that the iOS version of the Control Application does not support updating device firmware.

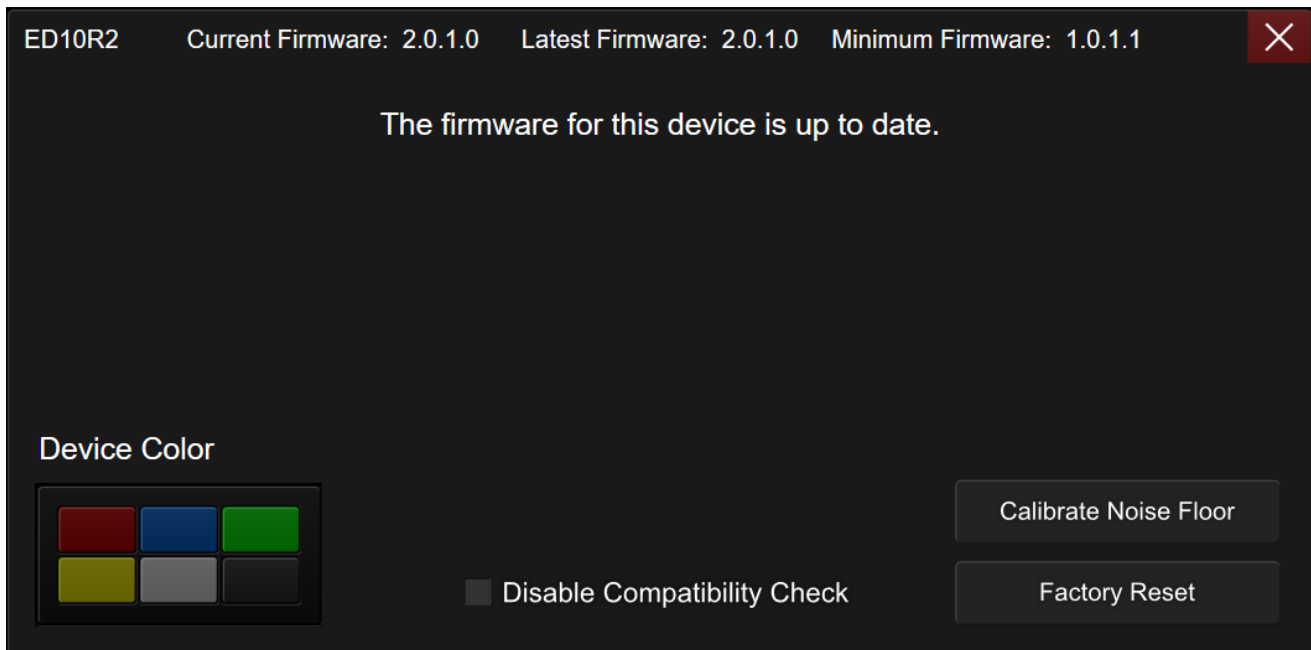

## Changing Colors

If you have more than one *eDRUMin* of the same color connected to the same computer, you might want to change the 'color' of one of the devices in order to change the name of its MIDI port to prevent your host sequencer and yourself from getting the devices mixed up.

## Calibrate Noise Floor

This function analyzes and calibrates the *eDRUMin* inputs to minimize the floor noise and maximize input sensitivity. Re calibrate the noise floor after performing a factory reset. For first generation ED4 (plastic casing), make sure pads are connected to all the trigger inputs before calibrating.

## Disable Compatibility Check

Normally, *eDRUMin* checks to make sure piezo / switch type pads are properly wired and will disable an input if it detects an issue. If you feel the device is incorrectly detecting an issue with one of your pads, you can disable this compatibility checking.

## Factory Reset

The wipes the device's memory and resets all settings to default.



# iOS Control Application

The control application is available as an iOS app from the Apple App Store.

## Getting Connected

The iOS version of the Control Application can communicate with the *eDRUMin* using the camera connection kit, or Network MIDI,

When the Control Application is opened, any connected to devices will automatically be detected. You can manually re-sync devices by clicking on the refresh icon.

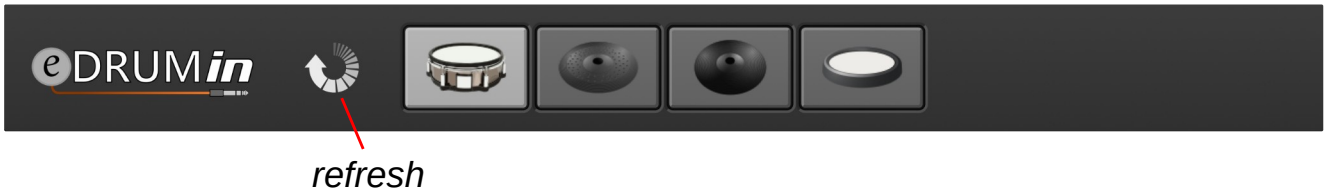

## Camera Connection Kit

Using the Apple Camera Connection kit, you can connect a *eDRUMin* directly to your iOS device. Using a USB hub is also supported, but if you plan to connect more than 2 *eDRUMin* devices, it will likely need to be a powered hub.



Simply plug in the devices and the Control Application should find them automatically.

## Network MIDI

You can also use the iOS Version of the Control Application to remotely control *eDRUMin* devices connected to a computer on your local network.



This is done using the Audio MIDI Setup

1. Open the Audio MIDI Setup, found in Utilities.

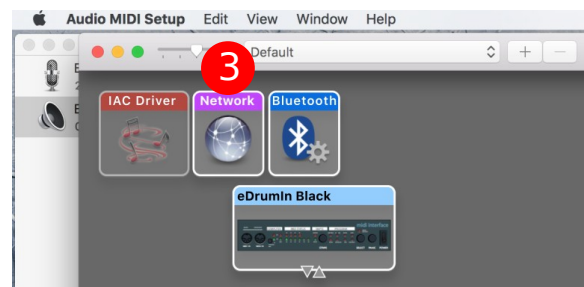
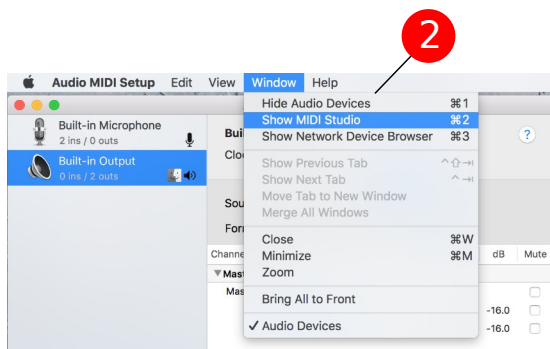

2. From the "Window" menu, select "Show MIDI Window".
3. Double click on the "Network" object.

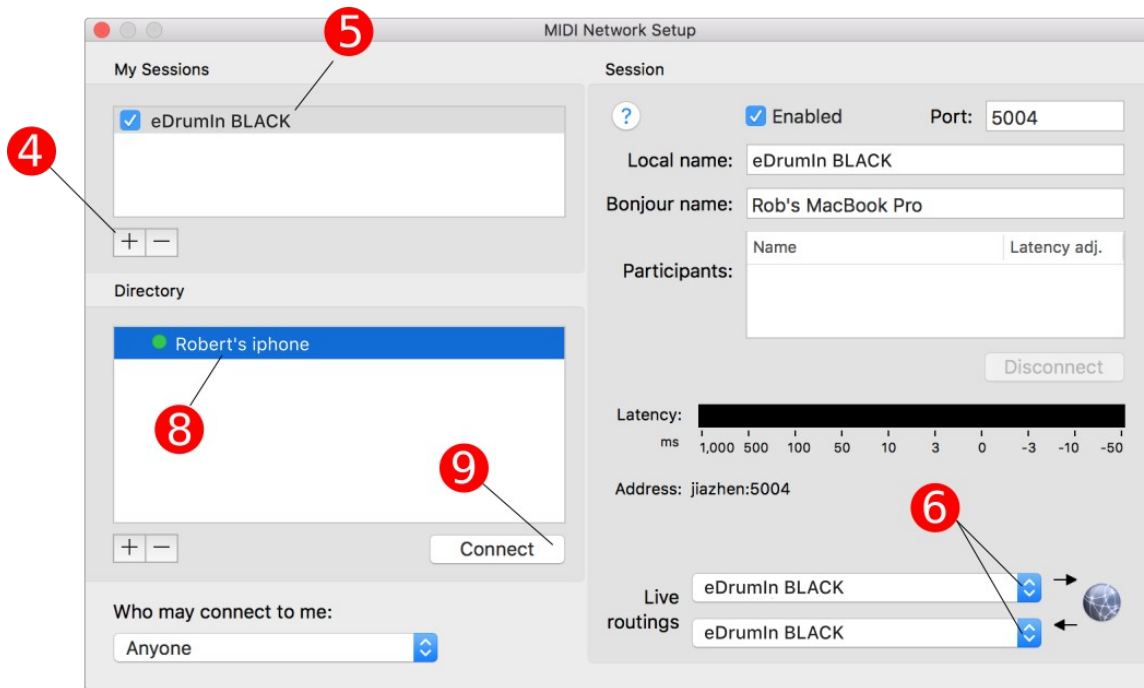

4. Click on the + sign to create a new session.
5. Give it a meaningful name and check the checkbox to enable it.
6. Setup the Live Routings. Be careful to pick the right MIDI Inputs. Do not chose the 'Network' MIDI connections.
7. Open the Control Application on your iOS device.
8. Select your iPhone or iPad.
9. Click on the Connect button.

The Control Application should automatically find and connect to your *eDRUMin*. You'll need to create and connect to a different session for each *eDRUMin* you want to connect to over the network.

## About Power in iOS

iOS powers down USB devices when it goes to sleep. If you would like to keep your *eDRUMin* powered and running, you can enabled the 'Keep Device Powered' switch from the sidebar.

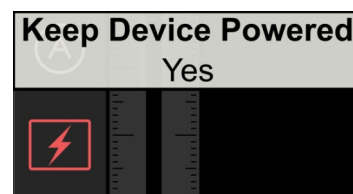

This will keep the iOS device awake and the *eDRUMin* powered as long the *eDRUMin* is actively being used. If no activity is detected for 1 minute, the iOS sleep function is re-enabled and the device will go to sleep as normal.

You can also chose to power the device with an external 9V power adapter while connected to iOS. This keep the device powered and functional even after the iOS device goes to sleep.

# Appendix

## Working With Multiple Devices on Separate USB Ports

You can connect as many eDRUMin devices to the same computer as you have USB connections. Each eDRUMin 4 needs about 70mA and each eDRUMin 10 needs about 100mA, so you should be fine using a standard unpowered 4 port USB hub. Updating the firmware while connected though a hub is not recommended.

### Managing Crosstalk Between Devices

Because multiple eDRUMin devices connected to separate USB port don't have any direct connection, crosstalk issues can occur when two adjacent pads, connected to the same mounting structure, are connected to separate eDRUMin devices.

There are two ways to avoid crosstalk problems. One way involves physical isolation of pads and cymbals, and the other involves routing MIDI from one device into the other.

#### Physical Isolation

Any pads connected to a common structure will experience crosstalk and so should be connected to a single eDRUMin so that the device can prevent this crosstalk from causing mistriggers. Pads and cymbals that use separate stands will not experience any crosstalk and therefore can be connected to a second unit without causing any mistrigging.

#### Crosstalk Cancellation via USB MIDI In



In some situations, physical isolation is not possible. In these cases, the only option for processing crosstalk between devices is to route MIDI from each device into each other device.

Because this method involves complicated MIDI routing, the only support I offer is a screenshot of the routing in Ableton Live. How this is accomplished in various hosts differs, but the general concept is the same.

The first track is the MIDI from both eDRUMin devices, which is sent to Superior Drummer.

The second track routes MIDI from the BLACK eDRUMin to the BLUE eDRUMin.

The last track routes MIDI from the BLUE eDRUMin to the BLACK eDRUMin.

There's no need to record the MIDI used for crosstalk processing, but the tracks do need to have monitoring enabled.

## Controlling Banks with MIDI Program Change Messages

A connected sustain pedal or dual footswitch is perfect for controlling banks of notes. If your pedal input is being used by a hihat controller, you can still configure a 3rd party MIDI device to send program changes into the eDRUMin via its USB port.

The MIDI channel of the program change message determines which input should change its bank. The value of the program change says how the bank should change.

### Use MIDI Channel to Target Input

Banks Changes can be sent any individual input, the selected input, or all the inputs. The MIDI channel of the program change message determines which input it is sent to.

Input(s)	MIDI Channel
1 - 4 (ED4)	1 - 4
1 - 10 (ED10)	1 - 10
Selected	15
All	16

The 'Selected' input is typically the last active input. If you hit a pad connected to input 1, then input 1 becomes the selected input. If you then hit a pad on input 3, input 3 becomes the selected input.

### Use Program Change Value to Specify Operation

The value of the Program Change message determines what it will do. It can select a specific bank, or increment / decrement a bank.

	Dual Zone Inputs, Mono Inputs, Left Bank of Dual Mono Input	Right Bank of Dual Mono Input
Select Bank 1	1	7
Select Bank 2	2	8
Select Bank 3	3	9
Select Bank 4	4	10
Decrement Bank	5	11
Increment Bank	6	12

Note: Inputs that are setup as Dual Mono have two sets of banks associated with them—one for each pad. To target the banks for left half of the input, use the first set of operations. To target the banks for the right half of the input, use the second set of operations.

## Setting up your Hihat on its Stand

To get the best performance possible from your hihat, it's important that it's setup properly on its stand. You know your setup is good when every slight movement of your hihat pedal registers in the Control Application. I'm going to go over setting up a Roland VH-10 as an example.

### ***Adjusting the hihat clutch***

Setting the height of your hihat correctly is very important for eliminating crosstalk between the hihat pedal and the hihat cymbal. If you set the hihat too high, the sensor on your hihat controller will not be able to detect when you very slightly press down on your hihat pedal. For optimum performance, the hihat cymbal should always be in contact with the plunger on the VH-10 controller.

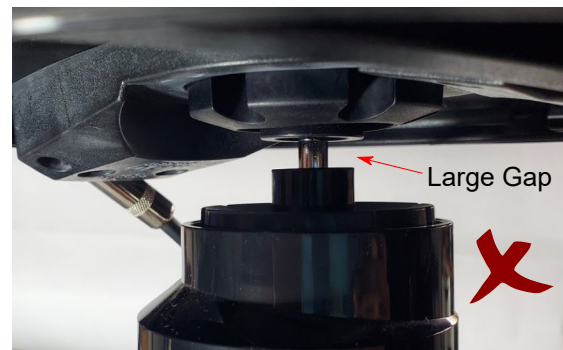
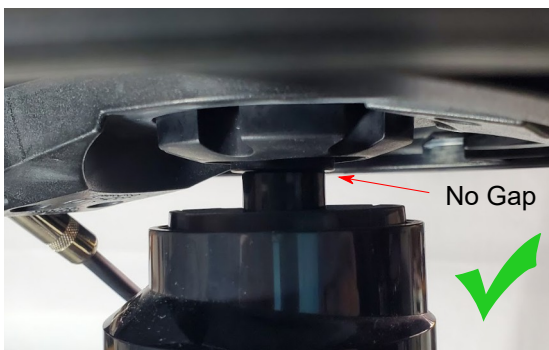

### ***Adjust the knob at the top of the cymbal***

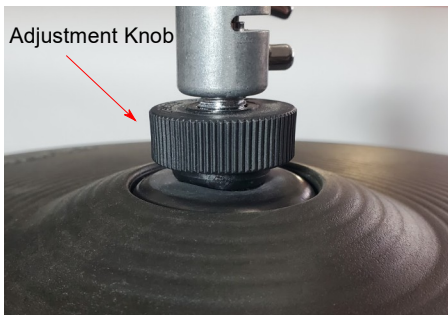

This knob allows you to adjust how much pressure is required to have to pedal register completely closed. Turning clockwise makes it more pressure sensitive and turning it anti-clockwise makes it less pressure sensitive.

For optimal performance with eDRUMin devices, turn the knob almost as much as it can go in the clockwise direction.

This allows the eDRUMin to more accurately track the position of the pedal, and also makes your hihat responsive to the amount of pressure you're applying when in the fully closed position.

### ***Calibrating***

After the hihat is setup properly on its stand, the next step is to calibrate it within the control application. Simply press the calibration button and press all the way down on your pedal, as hard as you would normally expect to have to press it. Make any final adjustments with the mouse. Make sure the red position indicator is even or further to the right of the green calibration rectangle when you foot is removed from the pedal.



# Tips For Working with Audiofront Controls

The page contains some bits of information that can improve your workflow when using Audiofront software.

## General Tips

- Use SHIFT modifiers for more precision.
- Use the mouse wheel for fine adjustments.
- Double-click to set defaults.

## Working with Note Controls



The values of these controls can be changed in a variety of ways.

- Drag the value up and down.
- Use the increment or decrement arrows.
- Double-click a control and enter the value as a note name 'C3' or as a note number '60'.

You can switch between displaying note numbers and note names by right clicking a note control (long press to touch devices). This will cause all note controls to change and the setting is saved and restored the next time you open the control application.

For controls that represent musical notes, the device will audition the notes as they are changed, allowing you to setup and test note assignments without any pads connected.

# Drum Pad Wiring Diagrams

**Dual Piezo Pad**  
(Roland Style)

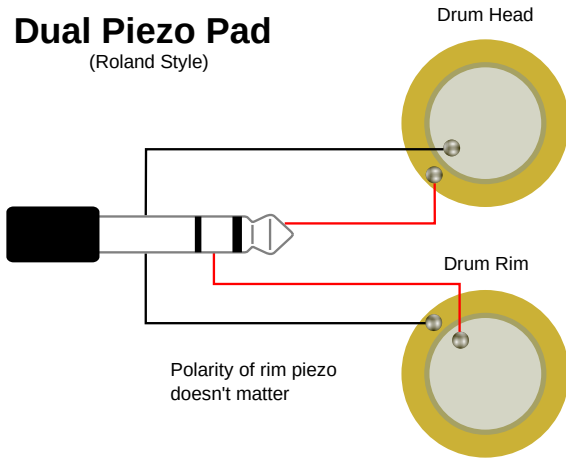

**Dual Piezo Pad**  
(Yamaha Style)

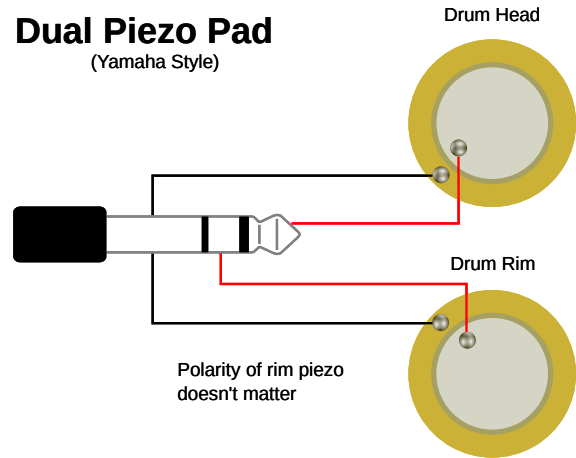

**Piezo / Switch Pad**  
(Roland Style)

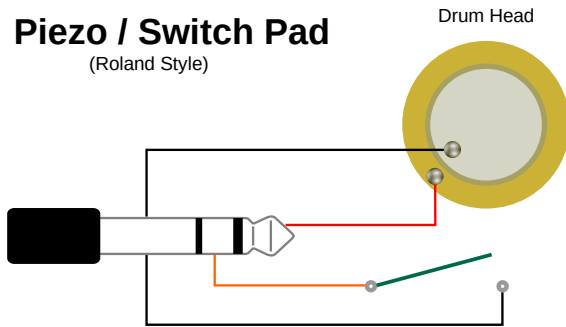

**Piezo / Switch Pad**  
(Yamaha Style)

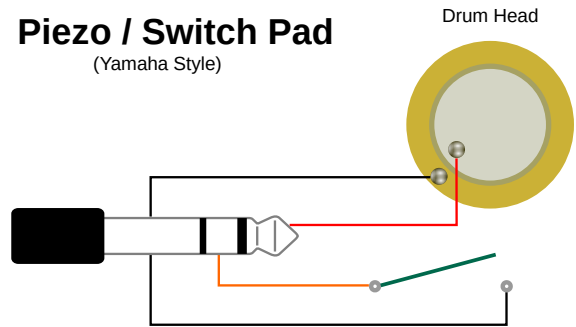

**Roland 3-Zone Ride Bell Input**

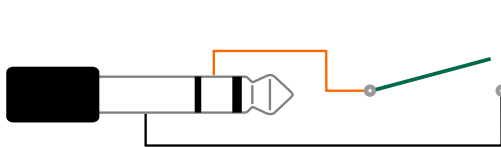

**Metal 3-Zone Ride Bell Input**

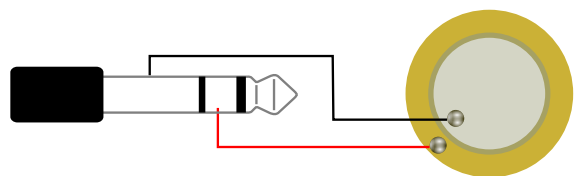

**Yamaha 3-Zone Cymbal**

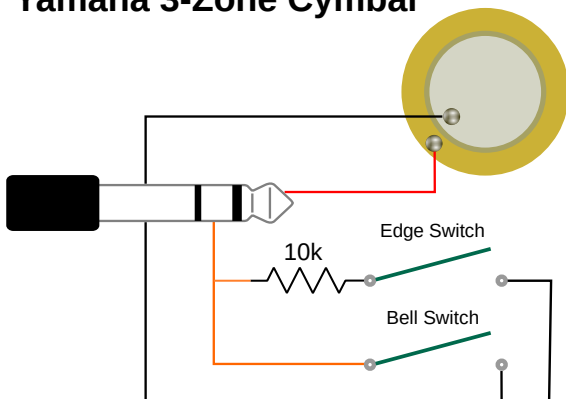

**Yamaha 3-Zone Pad**

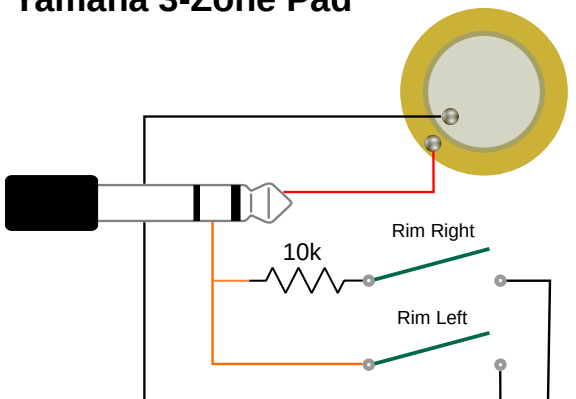

# Pedal Input Wiring Diagrams

Expression Pedal  
(straight polarity)

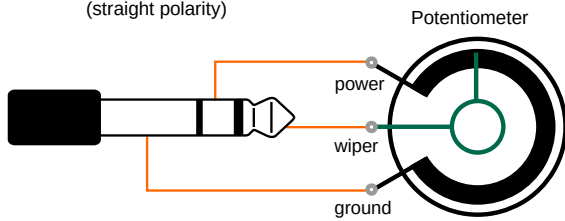

Expression Pedal  
(reversed polarity)

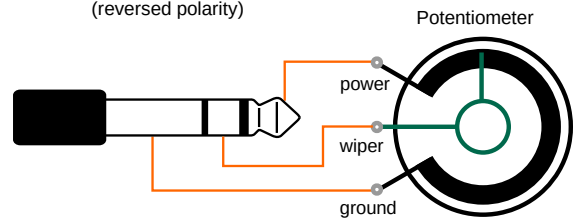

Sustain Pedal

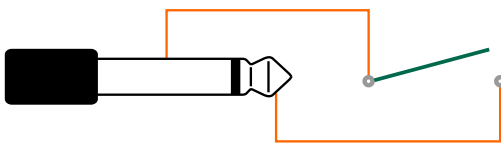

Dual Footswitch

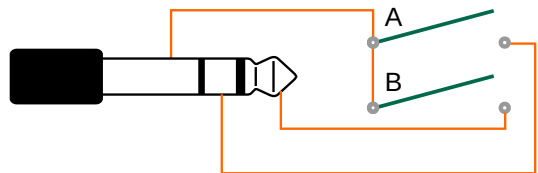

FSR Hihat Controller

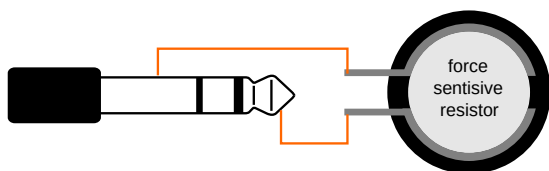

Hall Sensor Hihat Controller

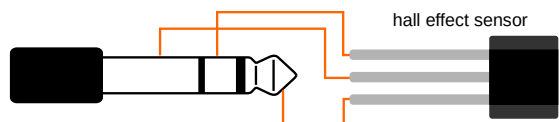

Recommended Hall Effect sensor: SS49E



Voltage on pedals inputs should be in the range of 0V to 3.3V. If externally powering a pedal input, you risk damaging the pedal input if the voltage goes outside of this range.



## MIDI Implementation

### MIDI Expression MIDI Implementation

Function	Transmit	Respond	Passthru	Remarks
Channel	1 - 16	1 - 16	1 - 16	Learn Note
Notes	0 - 127	0 - 127	0 - 127	Learn Note
Velocity	1 - 127	X	0 - 127	
Aftertouch	X	X	O	
PitchBend	O	X	O	14 bit
Control Change	0 - 127	0 - 127	0 - 127	Parameter Feedback
Program Change	0 - 127	X	0 - 127	
System Exclusive	O	O	O	Control, Display
System Real-Time	X	X	O	
System Common	X	X	O	
RPN / NRPN	X	X	O	

*Updated October 4th 2016*

X - Not Used

O - Used